

Slewing tower crane

WOLFF 6531.12 cross

Technical information

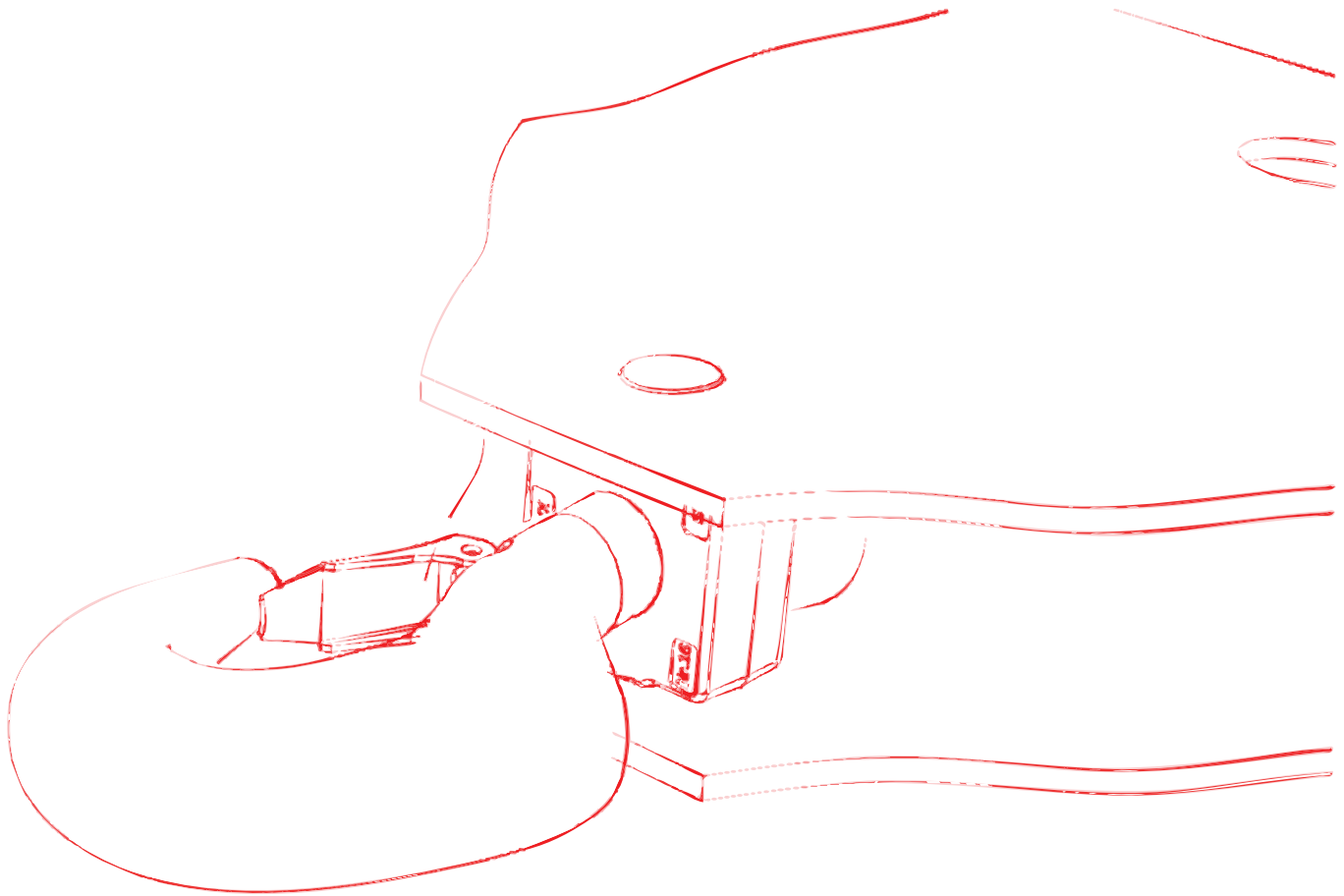

English

English



Published by

WOLFFKRAN GmbH

Austraße 72

74076 Heilbronn

Germany

Phone +49 7131 9815 0

Fax +49 7131 9815 355

www.wolffkran.com

info@wolffkran.de

Copyright

This documentation including all of its subsections is protected by copyright laws.

Any type of use or modification outside of the stringent limits of the copyright laws without permission of WOLFFKRAN GmbH is prohibited and subject to penalties.

This applies particularly for copying, translation, microfilming and storage and processing in electronic systems.

At the time of printing, the information, data, illustrations and notes comprised in this manual were up-to-date.

Subject to change of design, error and typos.

Stand: 03/2017

Table of contents

1	Schedule drawing	5
1.1	Schedule drawing WOLFF 6531.12cross	5
1.2	Schedule drawing WOLFF 6531.12cross	6
2	Load carrying capacities	7
2.1	Table of load carrying capacity WOLFF 6531.12 (6.0 t, 2 fall operation)	8
2.2	Table of load carrying capacities (kg) in meter intervals, WOLFF 6531.12 (6.0 t, 2 fall operation)	9
2.3	Table of load carrying capacity WOLFF 6531.12 (12.0 t, 4 fall operation)	10
2.4	Table of load carrying capacities (kg) in meter intervals, WOLFF 6531.12 (12.0 t, 4 fall operation)	11
2.5	Table of load carrying capacity WOLFF 6531.12 (8.3 t, 2 fall operation)	12
2.6	Table of load carrying capacities (kg) in meter intervals, WOLFF 6531.12 (8.3 t, 2 fall operation)	13
2.7	Table of load carrying capacity WOLFF 6531.12 (12.0 t, 4 fall operation)	14
2.8	Table of load carrying capacities (kg) in meter intervals, WOLFF 6531.12 (12.0 t, 4 fall operation)	15
3	Tower combinations	16
3.1	Tower combinations on foundation (slewing section with UV20/TV20 - connection)	17
3.2	Tower combinations on cross frame (slewing section with UV20/TV20 - connection)	21
3.3	Tower combinations on cross frame element (slewing section with UV20/TV20 - connection)	26
3.4	Tower combinations on mobile cross frame (slewing section with UV20/TV20 - connection)	28
3.5	Tower combinations on undercarriage (slewing section with UV20/TV20 - connection)	31
4	Foundation loads / central ballast weights / corner loads in compliance with EN 14439 / EN 13001	33
4.1	Foundation loads jib 30 m - 65 m	35
5	Operating speeds	36
6	Package list	39
6.1	Package list 6531.12	39
7	Assembly weights	41

7.1	Counterweight blocks	41
7.1.1	Counterweight block, 2.0 t	42
7.1.2	Counterweight block, 2.7 t	43
7.2	Total weight jib assembly	44
7.3	Assembly weight slewing section	45
7.4	Assembly weight cross frame	46
7.5	Assembly weights traveling cross frame	47
7.6	Assembly weight cross frame elements	49
7.7	Assembly weight undercarriage	50
7.8	Required hook height for mobile cranes	51
8	Assembly diagrams	53
8.1	Jib attachment diagram	53
8.1.1	Trolley jib - attachment diagram 2 / 4 fall operation	54
8.1.1.1	Trolley jib - attachment diagram 65 m to 50 m	54
8.1.1.2	Trolley jib - attachment diagram 45 m to 30 m	55
8.2	Jib brace diagram	56
8.3	Trolley jib mounting rig	57
8.4	Mounting rig for trolley jib	58
8.5	Arrangement of standard railings	59
8.5.1	Standard railings (NG) and accessories	59
8.5.2	Arrangement of standard railings	60
9	Suitable climbing devices	61
9.1	Outer climbing devices	62
9.1.1	Outer climbing device KWH 20.3 / KWH 20.3.1	63
9.1.2	Outer climbing device KWH 20.6 / KWH 20.6.1 / KWH 20.6.2	64
9.2	Inner climbing devices	65
9.2.1	Inner climbing device KSH 20 SH	66
10	Arrangement of counterweight blocks	69

1 Schedule drawing

1.1 Schedule drawing WOLFF 6531.12cross

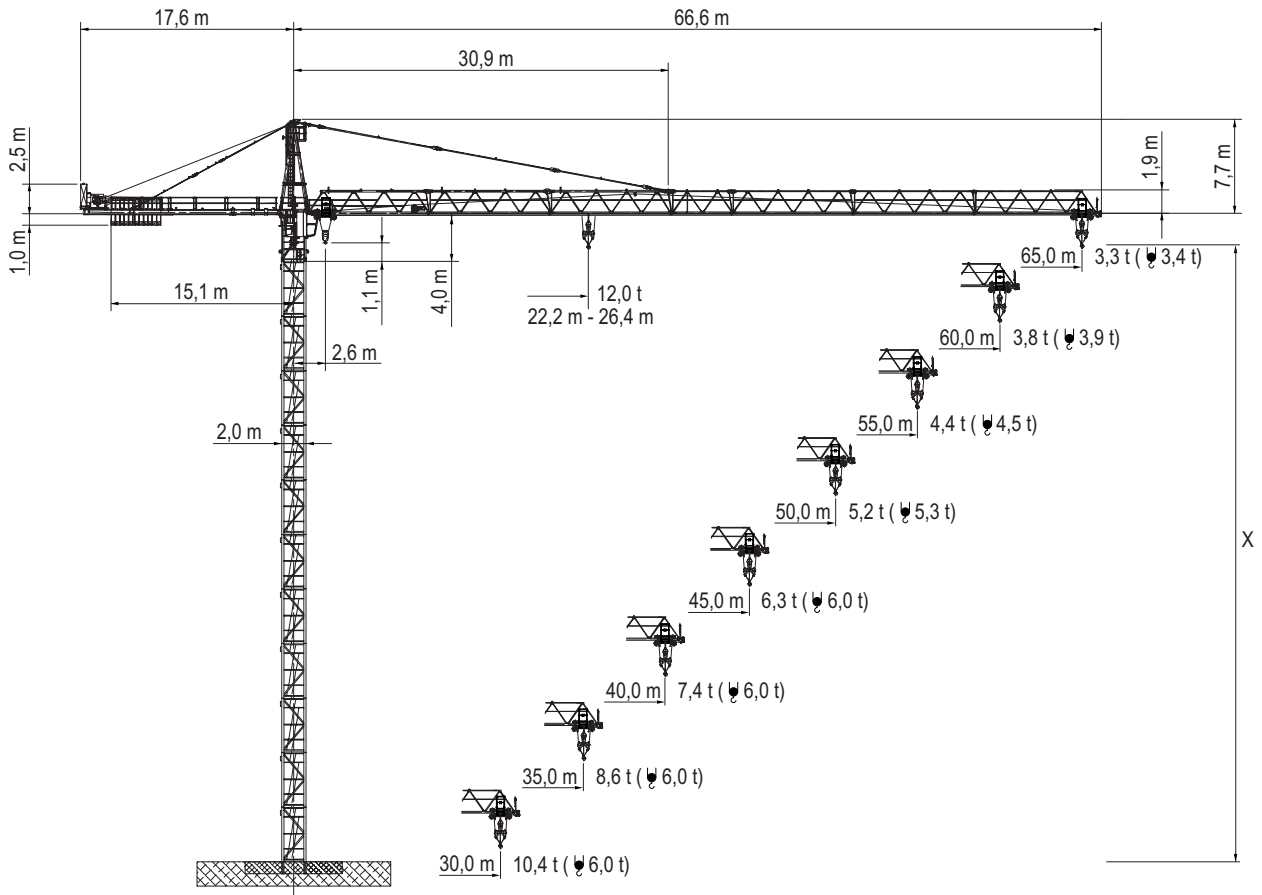

Data WOLFF 6531.12

Item	Data
Crane type	BGL GROUP C.0.10.0250
Design	Overhead travelling crane with top slewing trolley jib, with climbing feature
Type of setup	Stationary or travelling
Basis of calculation	EN 14439 (C25)
Payload torque	max. 3170 kNm
Hoist winch	Hw 645 FU / Hw 675 FU

2 Load carrying capacities



NOTICE

WOLFF-Boost

With the WOLFF-Boost function, the load is allowed to exceed the load torque range specified for the lifting capacities by up to 10%. This is, however, subject to the restriction that hoisting gear and trolley drive (trolley crane) respectively hoisting gear and derricking gear (luffing crane) must only be moved alternately.

2 Load carrying capacities

2.1 Table of load carrying capacity WOLFF 6531.12 (6.0 t, 2 fall operation)

Load carrying capacity with Hw645FU / Hw675FU

6.0 t		Operating radius [m]	20.0	25.0	30.0	35.0	40.0	45.0	50.0	55.0	60.0	65.0	
JL [m]	65.0	2.6 – 41.2	6.0	6.0	6.0	6.0	6.0	5.4	4.8	4.2	3.8	3.4	LCC [t]
	60.0	2.6 – 42.3	6.0	6.0	6.0	6.0	6.0	5.6	4.9	4.4	3.9		
	55.0	2.6 – 43.4	6.0	6.0	6.0	6.0	6.0	5.8	5.1	4.5			
	50.0	2.6 – 45.1	6.0	6.0	6.0	6.0	6.0	6.0	5.3				
	45.0	2.6 – 45.0	6.0	6.0	6.0	6.0	6.0	6.0					
	40.0	2.6 – 40.0	6.0	6.0	6.0	6.0	6.0						
	35.0	2.6 – 35.0	6.0	6.0	6.0	6.0							
	30.0	2.6 – 30.0	6.0	6.0	6.0								

JL	Jib length
LCC	Load carrying capacity

The load carrying capacity is related to a hook range of 42.0 m. Hook ranges greater than that reduce the maximum load carrying capacity by the weight of the additional hoisting ropes (2 fall operation = 2.4 kg per meter of the hook range).

2.2 Table of load carrying capacities (kg) in meter intervals, WOLFF 6531.12 (6.0 t, 2 fall operation)

Load carrying capacity with Hw645FU / Hw675FU

Operating radius	Jib length [m]							
[m]	30.0	35.0	40.0	45.0	50.0	55.0	60.0	65.0
10	6000	6000	6000	6000	6000	6000	6000	6000
11	6000	6000	6000	6000	6000	6000	6000	6000
12	6000	6000	6000	6000	6000	6000	6000	6000
13	6000	6000	6000	6000	6000	6000	6000	6000
14	6000	6000	6000	6000	6000	6000	6000	6000
15	6000	6000	6000	6000	6000	6000	6000	6000
16	6000	6000	6000	6000	6000	6000	6000	6000
17	6000	6000	6000	6000	6000	6000	6000	6000
18	6000	6000	6000	6000	6000	6000	6000	6000
19	6000	6000	6000	6000	6000	6000	6000	6000
20	6000	6000	6000	6000	6000	6000	6000	6000
21	6000	6000	6000	6000	6000	6000	6000	6000
22	6000	6000	6000	6000	6000	6000	6000	6000
23	6000	6000	6000	6000	6000	6000	6000	6000
24	6000	6000	6000	6000	6000	6000	6000	6000
25	6000	6000	6000	6000	6000	6000	6000	6000
26	6000	6000	6000	6000	6000	6000	6000	6000
27	6000	6000	6000	6000	6000	6000	6000	6000
28	6000	6000	6000	6000	6000	6000	6000	6000
29	6000	6000	6000	6000	6000	6000	6000	6000
30	6000	6000	6000	6000	6000	6000	6000	6000
31		6000	6000	6000	6000	6000	6000	6000
32		6000	6000	6000	6000	6000	6000	6000
33		6000	6000	6000	6000	6000	6000	6000
34		6000	6000	6000	6000	6000	6000	6000
35		6000	6000	6000	6000	6000	6000	6000
36			6000	6000	6000	6000	6000	6000
37			6000	6000	6000	6000	6000	6000
38			6000	6000	6000	6000	6000	6000
39			6000	6000	6000	6000	6000	6000
40			6000	6000	6000	6000	6000	6000
41				6000	6000	6000	6000	6000
42				6000	6000	6000	6000	5870
43				6000	6000	6000	5880	5710
44				6000	6000	5900	5720	5550
45				6000	6000	5750	5570	5400
46					5860	5600	5420	5260
47					5710	5450	5290	5130
48					5570	5320	5150	5000
49					5430	5190	5020	4870
50					5300	5060	4900	4750
51						4940	4780	4640
52						4820	4670	4530
53						4710	4560	4420
54						4600	4460	4320
55						4500	4360	4220
56							4260	4120
57							4160	4030
58							4070	3940
59							3980	3860
60							3900	3780
61								3700
62								3620
63								3540
64								3470
65								3400

2 Load carrying capacities

2.3 Table of load carrying capacity WOLFF 6531.12 (12.0 t, 4 fall operation)

Load carrying capacity with Hw645FU / Hw675FU

 12.0 t		Operating radius [m]	20.0	25.0	30.0	35.0	40.0	45.0	50.0	55.0	60.0	65.0	
JL [m]	65.0	2.6 – 22.2	12.0	10.5	8.6	7.2	6.1	5.3	4.7	4.1	3.7	3.3	LCC [t]
	60.0	2.6 – 22.8	12.0	10.8	8.8	7.4	6.3	5.5	4.8	4.3	3.8		
	55.0	2.6 – 23.4	12.0	11.1	9.1	7.6	6.5	5.7	5.0	4.4			
	50.0	2.6 – 24.3	12.0	11.6	9.5	8.0	6.8	5.9	5.2				
	45.0	2.6 – 25.6	12.0	12.0	10.1	8.5	7.2	6.3					
	40.0	2.6 – 26.1	12.0	12.0	10.3	8.6	7.4						
	35.0	2.6 – 26.0	12.0	12.0	10.2	8.6							
	30.0	2.6 – 26.4	12.0	12.0	10.4								

JL	Jib length
LCC	Load carrying capacity

The load carrying capacity is related to a hook range of 42.0 m. Hook ranges greater than that reduce the maximum load carrying capacity by the weight of the additional hoisting ropes (4 fall operation = 4.8 kg per meter of the hook range).

2.4 Table of load carrying capacities (kg) in meter intervals, WOLFF 6531.12 (12.0 t, 4 fall operation)

Load carrying capacity with Hw645FU / Hw675FU

Operating radius [m]	Jib length [m]							
	30.0	35.0	40.0	45.0	50.0	55.0	60.0	65.0
10	12000	12000	12000	12000	12000	12000	12000	12000
11	12000	12000	12000	12000	12000	12000	12000	12000
12	12000	12000	12000	12000	12000	12000	12000	12000
13	12000	12000	12000	12000	12000	12000	12000	12000
14	12000	12000	12000	12000	12000	12000	12000	12000
15	12000	12000	12000	12000	12000	12000	12000	12000
16	12000	12000	12000	12000	12000	12000	12000	12000
17	12000	12000	12000	12000	12000	12000	12000	12000
18	12000	12000	12000	12000	12000	12000	12000	12000
19	12000	12000	12000	12000	12000	12000	12000	12000
20	12000	12000	12000	12000	12000	12000	12000	12000
21	12000	12000	12000	12000	12000	12000	12000	12000
22	12000	12000	12000	12000	12000	12000	12000	12000
23	12000	12000	12000	12000	12000	12000	11860	11540
24	12000	12000	12000	12000	12000	11650	11320	11000
25	12000	12000	12000	12000	11610	11130	10810	10520
26	12000	12000	12000	11790	11120	10660	10350	10070
27	11690	11510	11550	11310	10660	10220	9920	9650
28	11230	11050	11090	10860	10240	9810	9530	9260
29	10800	10630	10670	10440	9840	9430	9160	8900
30	10400	10240	10270	10060	9470	9080	8810	8560
31		9870	9900	9690	9130	8740	8490	8250
32		9520	9550	9350	8810	8430	8180	7950
33		9190	9230	9030	8500	8140	7900	7670
34		8890	8920	8730	8220	7870	7630	7410
35		8600	8630	8450	7950	7610	7380	7170
36			8360	8180	7690	7360	7140	6930
37			8100	7920	7450	7130	6910	6710
38			7850	7680	7220	6910	6700	6500
39			7620	7460	7010	6700	6500	6310
40			7400	7240	6800	6500	6310	6120
41				7030	6610	6320	6120	5940
42				6840	6420	6140	5950	5770
43				6650	6240	5970	5780	5610
44				6470	6070	5800	5620	5450
45				6300	5910	5650	5470	5300
46					5760	5500	5320	5160
47					5610	5350	5190	5030
48					5470	5220	5050	4900
49					5330	5090	4920	4770
50					5200	4960	4800	4650
51						4840	4680	4540
52						4720	4570	4430
53						4610	4460	4320
54						4500	4360	4220
55						4400	4260	4120
56							4160	4020
57							4060	3930
58							3970	3840
59							3880	3760
60							3800	3680
61								3600
62								3520
63								3440
64								3370
65								3300

2 Load carrying capacities

2.5 Table of load carrying capacity WOLFF 6531.12 (8.3 t, 2 fall operation)

Load carrying capacity with Hw845FU

8.3 t		Operating radius [m]	20.0	25.0	30.0	35.0	40.0	45.0	50.0	55.0	60.0	65.0	
JL [m]	65.0	2.6 – 30.8	8.3	8.3	8.3	7.2	6.1	5.3	4.7	4.1	3.7	3.3	LCC [t]
	60.0	2.6 – 31.6	8.3	8.3	8.3	7.4	6.3	5.5	4.8	4.3	3.8		
	55.0	2.6 – 32.4	8.3	8.3	8.3	7.6	6.5	5.7	5.0	4.4			
	50.0	2.6 – 33.7	8.3	8.3	8.3	8.0	6.8	5.9	5.2				
	45.0	2.6 – 35.5	8.3	8.3	8.3	8.3	7.2	6.3					
	40.0	2.6 – 36.2	8.3	8.3	8.3	8.3	7.4						
	35.0	2.6 – 35.0	8.3	8.3	8.3	8.3							
	30.0	2.6 – 30.0	8.3	8.3	8.3								

JL	Jib length
LCC	Load carrying capacity

The load carrying capacity is related to a hook range of 42.0 m. Hook ranges greater than that reduce the maximum load carrying capacity by the weight of the additional hoisting ropes (2 fall operation = 2.5 kg per meter of the hook range).

2.6 Table of load carrying capacities (kg) in meter intervals, WOLFF 6531.12 (8.3 t, 2 fall operation)

Load carrying capacity with Hw845FU

Operating radius	Jib length [m]							
[m]	30.0	35.0	40.0	45.0	50.0	55.0	60.0	65.0
10	8300	8300	8300	8300	8300	8300	8300	8300
11	8300	8300	8300	8300	8300	8300	8300	8300
12	8300	8300	8300	8300	8300	8300	8300	8300
13	8300	8300	8300	8300	8300	8300	8300	8300
14	8300	8300	8300	8300	8300	8300	8300	8300
15	8300	8300	8300	8300	8300	8300	8300	8300
16	8300	8300	8300	8300	8300	8300	8300	8300
17	8300	8300	8300	8300	8300	8300	8300	8300
18	8300	8300	8300	8300	8300	8300	8300	8300
19	8300	8300	8300	8300	8300	8300	8300	8300
20	8300	8300	8300	8300	8300	8300	8300	8300
21	8300	8300	8300	8300	8300	8300	8300	8300
22	8300	8300	8300	8300	8300	8300	8300	8300
23	8300	8300	8300	8300	8300	8300	8300	8300
24	8300	8300	8300	8300	8300	8300	8300	8300
25	8300	8300	8300	8300	8300	8300	8300	8300
26	8300	8300	8300	8300	8300	8300	8300	8300
27	8300	8300	8300	8300	8300	8300	8300	8300
28	8300	8300	8300	8300	8300	8300	8300	8300
29	8300	8300	8300	8300	8300	8300	8300	8300
30	8300	8300	8300	8300	8300	8300	8300	8300
31		8300	8300	8300	8300	8300	8300	8250
32		8300	8300	8300	8300	8300	8180	7950
33		8300	8300	8300	8300	8140	7900	7670
34		8300	8300	8300	8220	7870	7630	7410
35		8300	8300	8300	7950	7610	7380	7170
36			8300	8180	7690	7360	7140	6930
37			8100	7920	7450	7130	6910	6710
38			7850	7680	7220	6910	6700	6500
39			7620	7460	7010	6700	6500	6310
40			7400	7240	6800	6500	6310	6120
41				7030	6610	6320	6120	5940
42				6840	6420	6140	5950	5770
43				6650	6240	5970	5780	5610
44				6470	6070	5800	5620	5450
45				6300	5910	5650	5470	5300
46					5760	5500	5320	5160
47					5610	5350	5190	5030
48					5470	5220	5050	4900
49					5330	5090	4920	4770
50					5200	4960	4800	4650
51						4840	4680	4540
52						4720	4570	4430
53						4610	4460	4320
54						4500	4360	4220
55						4400	4260	4120
56							4160	4020
57							4060	3930
58							3970	3840
59							3880	3760
60							3800	3680
61								3600
62								3520
63								3440
64								3370
65								3300

2 Load carrying capacities

2.7 Table of load carrying capacity WOLFF 6531.12 (12.0 t, 4 fall operation)

Load carrying capacity with Hw845FU

 12.0 t		Operating radius [m]	20.0	25.0	30.0	35.0	40.0	45.0	50.0	55.0	60.0	65.0	
JL [m]	65.0	2.6 – 22.0	12.0	10.4	8.5	7.1	6.0	5.2	4.6	4.0	3.6	3.2	LCC [t]
	60.0	2.6 – 22.6	12.0	10.7	8.7	7.3	6.2	5.4	4.7	4.2	3.7		
	55.0	2.6 – 23.2	12.0	11.0	9.0	7.5	6.4	5.6	4.9	4.3			
	50.0	2.6 – 24.1	12.0	11.5	9.4	7.9	6.7	5.8	5.1				
	45.0	2.6 – 25.4	12.0	12.0	10.0	8.4	7.1	6.2					
	40.0	2.6 – 25.9	12.0	12.0	10.2	8.5	7.3						
	35.0	2.6 – 25.8	12.0	12.0	10.1	8.5							
	30.0	2.6 – 26.2	12.0	12.0	10.3								

JL	Jib length
LCC	Load carrying capacity

The load carrying capacity is related to a hook range of 42.0 m. Hook ranges greater than that reduce the maximum load carrying capacity by the weight of the additional hoisting ropes (4 fall operation = 5.0 kg per meter of the hook range).





2.8 Table of load carrying capacities (kg) in meter intervals, WOLFF 6531.12 (12.0 t, 4 fall operation)

Load carrying capacity with Hw845FU

Operating radius	Jib length [m]							
[m]	30.0	35.0	40.0	45.0	50.0	55.0	60.0	65.0
10	12000	12000	12000	12000	12000	12000	12000	12000
11	12000	12000	12000	12000	12000	12000	12000	12000
12	12000	12000	12000	12000	12000	12000	12000	12000
13	12000	12000	12000	12000	12000	12000	12000	12000
14	12000	12000	12000	12000	12000	12000	12000	12000
15	12000	12000	12000	12000	12000	12000	12000	12000
16	12000	12000	12000	12000	12000	12000	12000	12000
17	12000	12000	12000	12000	12000	12000	12000	12000
18	12000	12000	12000	12000	12000	12000	12000	12000
19	12000	12000	12000	12000	12000	12000	12000	12000
20	12000	12000	12000	12000	12000	12000	12000	12000
21	12000	12000	12000	12000	12000	12000	12000	12000
22	12000	12000	12000	12000	12000	12000	12000	12000
23	12000	12000	12000	12000	12000	12000	11760	11440
24	12000	12000	12000	12000	12000	11550	11220	10900
25	12000	12000	12000	12000	11510	11030	10710	10420
26	12000	11900	11940	11690	11020	10560	10250	9970
27	11590	11410	11450	11210	10560	10120	9820	9550
28	11130	10950	10990	10760	10140	9710	9430	9160
29	10700	10530	10570	10340	9740	9330	9060	8800
30	10300	10140	10170	9960	9370	8980	8710	8460
31		9770	9800	9590	9030	8640	8390	8150
32		9420	9450	9250	8710	8330	8080	7850
33		9090	9130	8930	8400	8040	7800	7570
34		8790	8820	8630	8120	7770	7530	7310
35		8500	8530	8350	7850	7510	7280	7070
36			8260	8080	7590	7260	7040	6830
37			8000	7820	7350	7030	6810	6610
38			7750	7580	7120	6810	6600	6400
39			7520	7360	6910	6600	6400	6210
40			7300	7140	6700	6400	6210	6020
41				6930	6510	6220	6020	5840
42				6740	6320	6040	5850	5670
43				6550	6140	5870	5680	5510
44				6370	5970	5700	5520	5350
45				6200	5810	5550	5370	5200
46					5660	5400	5220	5060
47					5510	5250	5090	4930
48					5370	5120	4950	4800
49					5230	4990	4820	4670
50					5100	4860	4700	4550
51						4740	4580	4440
52						4620	4470	4330
53						4510	4360	4220
54						4400	4260	4120
55						4300	4160	4020
56							4060	3920
57							3960	3830
58							3870	3740
59							3780	3660
60							3700	3580
61								3500
62								3420
63								3340
64								3270
65								3200

3 Tower combinations

3 Tower combinations

	<p style="text-align: center;">! DANGER</p> <p>Usage of incorrect tower combinations. The slewing tower crane may overturn.</p> <ol style="list-style-type: none">1) Use the specified tower combinations.2) If you need another tower combination that is not specified here, please contact WOLFFKRAN to get an approved alternative setup in writing.
	<p style="text-align: center;">NOTICE</p> <p>All tower combinations apply to free standing slewing tower cranes without climbing gear.</p>
	<p style="text-align: center;">NOTICE</p> <p>For tower combination with tower element TV 25 and UV 25 please contact WOLFFKRAN.</p>
	<p style="text-align: center;">NOTICE</p> <p>4 fall operation only with the 6531.12cross. The 4 fall hook height is only for the crane 6531.12 cross in 4 fall operation.</p>

3.1 Tower combinations on foundation (slewing section with UV20/TV20 - connection)

Jib length	30 m – 65 m			
Item				
1	4.5 m	UV 20.4	TV 20.4	UV 20.4
2	9.0 m	UV 20.4	TV 20.4	UV 20.4
3	13.5 m	UV 20.4	TV 20.4	UV 20.4
4	18.0 m	UV 20.4	TV 20.4	UV 20.4
5	22.5 m	UV 20.4	TV 20.4	UV 20.4
6	27.0 m	UV 20.4	TV 20.4	UV 20.4
7	31.5 m	UV 20.4	TV 20.4	UV 20.4
8	36.0 m	UV 20.4	TV 20.4	UV 20.4
9	40.5 m	UV 20.4	TV 20.4	TVA 20.4
10	45.0 m	UV 20.4	TV 20.4	TV 20.4
11	49.5 m		TV 20.4	TV 20.4
12	54.0 m		TV 20.4	TV 20.4
13	58.5 m		TV 20.4	TV 20.4
14	63.0 m		TV 20.4	TV 20.4
15	67.5 m			TV 20.4
Foundation anchors		FUA 120 / Type C-120	FUA 140 / Type D-140	FUA 140 / Type D-140
Tower height [m]		45.0	63.0	67.5
Hook height double reeving [m]		46.5	64.5	69.0
Hook height 4 fall operation [m]		46.1	64.1	68.6
Wind category		C25		

3.2 Tower combinations on cross frame (slewing section with UV20/TV20 - connection)

Jib length	30 m – 65 m			
Item				
1	4.5 m	UV 20.4	UV 20.4	UV 20.4
2	9.0 m	UV 20.4	UV 20.4	UV 20.4
3	13.5 m	UV 20.4	UV 20.4	UV 20.4
4	18.0 m	UV 20.4	UV 20.4	UV 20.4
5	22.5 m	UV 20.4	UV 20.4	UV 20.4
6	27.0 m	UV 20.4	UV 20.4	UV 20.4
7	31.5 m	UV 20.4	UV 20.4	UV 20.4
8	36.0 m	UV 20.4	UV 20.4	UV 20.4
9	40.5 m	UV 20.4	TVA 20.4	UV 20.4
10	45.0 m	TVA 20.4	TV 20.4	TVA 20.4
11	49.5 m	TV 20.4	TV 20.4	TV 20.4
12	54.0 m	TV 20.4	TV 20.4	TV 20.4
13	58.5 m		TV 20.4	TV 20.4
14	63.0 m		TV 20.4	TV 20.4
15	67.5 m		TV 20.4	
Substructure		KR 10-46 KR10-46/60	KRV 10-60	KRV 10-60
Corner distance [m x m]		4.6 x 4.6 6.0 x 6.0	5.0 x 5.0	6.0 x 6.0
Substructure height [m]		1.2	1.2	1.2
Tower height [m]		55.2	68.7	64.2
Hook height double reeving [m]		56.7	70.2	65.7
Hook height 4 fall operation [m]		56.3	69.8	65.3
Wind category		C25		

Jib length	30 m – 65 m			
Item				
1	4.5 m	UV 20.4	UV 20.4	
2	9.0 m	UV 20.4	UV 20.4	
3	13.5 m	UV 20.4	UV 20.4	
4	18.0 m	UV 20.4	UV 20.4	
5	22.5 m	UV 20.4	UV 20.4	
6	27.0 m	UV 20.4	UV 20.4	
7	31.5 m	UV 20.4	UV 20.4	
8	36.0 m	UV 20.4	UV 20.4	
9	40.5 m	UV 20.4	TVA 20.4	
10	45.0 m	TVA 20.4	TV 20.4	
11	49.5 m	TV 20.4	TV 20.4	
12	54.0 m	TV 20.4	TV 20.4	
13	58.5 m	TVÜ 20.4	TV 20.4	
14	63.0 m	TV 25	TV 20.4	
15	67.5 m		TV 20.4	
Substructure		KR 1000-8	KR 12-60 KR 12-60/80	
Corner distance [m x m]		8.0 x 8.0	6.0 x 6.0 8.0 x 8.0	
Substructure height [m]		1.2	1.4	
Tower height [m]		64.2	68.9	
Hook height double reeving [m]		65.7	70.4	
Hook height quadruple reeving [m]		65.3	70.0	
Wind category		C25		

3 Tower combinations

Jib length	30 m – 65 m			
Item				
1	4.5 m	UV 20.4	UV 20.4	
2	9.0 m	UV 20.4	UV 20.4	
3	13.5 m	UV 20.4	UV 20.4	
4	18.0 m	UV 20.4	UV 20.4	
5	22.5 m	UV 20.4	UV 20.4	
6	27.0 m	UV 20.4	UV 20.4	
7	31.5 m	UV 20.4	UV 20.4	
8	36.0 m	UV 20.4	UV 20.4	
9	40.5 m	TVA 20.4	TVA 20.4	
10	45.0 m	TV 20.4	TV 20.4	
11	49.5 m	TV 20.4	TV 20.4	
12	54.0 m	TV 20.4	TV 20.4	
13	58.5 m	TV 20.4	TV 20.4	
14	59.5 m	VR 2023	VR 2023	
15	64.0 m	TV 23	TV 23	
16	68.5 m	HTA 23	HTA 23	
17	73.0 m	HT 23	HT 23	
18	77.5 m	HT 23	HT 23	
Substructure		KR 12-60 KR 12-60/80	KR 16-80 KR 16-80/100	
Corner distance [m x m]		6.0 x 6.0 8.0 x 8.0	8.0 x 8.0 10.0 x 10.0	
Substructure height [m]		1.4	1.8	
Tower height [m]		78.9	79.3	
Hook height double reeving [m]		80.4	80.8	
Hook height 4 fall operation [m]		80.0	80.4	
Wind category		C25		

3 Tower combinations

3.3 Tower combinations on cross frame element (slewing section with UV20/TV20 - connection)

Jib length		30 m – 65 m			
Item					
1	4.5 m	UV 20.4	UV 20.4	UV 20.4	UV 20.4
2	9.0 m	UV 20.4	UV 20.4	UV 20.4	UV 20.4
3	13.5 m	UV 20.4	UV 20.4	UV 20.4	UV 20.4
4	18.0 m		UV 20.4	UV 20.4	UV 20.4
5	22.5 m		UV 20.4	UV 20.4	UV 20.4
6	27.0 m		UV 20.4	UV 20.4	UV 20.4
7	31.5 m		UV 20.4	TVA 20.4	UV 20.4
8	36.0 m		UV 20.4	TV 20.4	UV 20.4
9	40.5 m		TVA 20.4	TV 20.4	UV 20.4
10	45.0 m			TV 20.4	TVA 20.4
11	49.5 m				TV 20.4
Substructure		KRE 260.1	KRE 260.2	KRE 260.2	KRE 260.2
Corner distance [m x m]		6.0 x 6.0	5.0 x 6.79	5.0 x 6.79	6.0 x 6.0
Substructure height [m]		4.0	4.0	4.0	4.0
Tower height [m]		17.5	44.5	49.0	53.5
Hook height double reeving [m]		19.0	46.0	50.5	55.0
Hook height 4 fall operation [m]		18.6	45.6	50.1	54.6
Wind category		C25			

Jib length	30 m – 65 m			
Item				
1	4.5 m	UV 20.4		
2	9.0 m	UV 20.4		
3	13.5 m	UV 20.4		
4	18.0 m	UV 20.4		
5	22.5 m	UV 20.4		
6	27.0 m	UV 20.4		
7	31.5 m	UV 20.4		
8	36.0 m	UV 20.4		
9	40.5 m	TVA 20.4		
10	45.0 m	TV 20.4		
11	49.5 m	TV 20.4		
12	54.0 m	TV 20.4		
13	58.5 m	TVÜ 20.4		
14	63.0 m	UVA 25		
Substructure		KRE 480		
Corner distance [m x m]		8.0 x 8.0		
Substructure height [m]		4.0		
Tower height [m]		67.0		
Hook height double reeving [m]		68.5		
Hook height 4 fall operation [m]		68.1		
Wind category			C25	

3 Tower combinations

3.4 Tower combinations on mobile cross frame (slewing section with UV20/TV20 - connection)

Jib length		30 m – 65 m			
Item					
1	4.5 m	UV 20.4	UV 20.4	UV 20.4	
2	9.0 m	UV 20.4	UV 20.4	UV 20.4	
3	13.5 m	UV 20.4	UV 20.4	UV 20.4	
4	18.0 m	UV 20.4	UV 20.4	UV 20.4	
5	22.5 m	UV 20.4	UV 20.4	UV 20.4	
6	27.0 m	UV 20.4	UV 20.4	UV 20.4	
7	31.5 m	UV 20.4	UV 20.4	UV 20.4	
8	36.0 m	UV 20.4	TVA 20.4	TVA 20.4	
9	40.5 m	TVA 20.4	TV 20.4	TV 20.4	
10	45.0 m	TV 20.4	TV 20.4	TV 20.4	
11	49.5 m	TV 20.4	TV 20.4	TV 20.4	
12	54.0 m	TV 20.4	TV 20.4	TV 20.4	
13	58.5 m		TV 20.4	TV 20.4	
14	63.0 m		TV 20.4	TV 20.4	
Substructure		KRF 10-46/60	KRF4 12-60/80	KRF6 12-60/80	
Corner distance [m x m]		6.0 x 6.0	8.0 x 8.0	8.0 x 8.0	
Substructure height [m]		2.0	2.5	2.9	
Tower height [m]		56.0	65.5	65.9	
Hook height double reeving [m]		57.5	67.0	67.4	
Hook height 4 fall operation [m]		57.1	66.6	67.0	
Wind category		C25			

Jib length	30 m – 65 m			
Item				
1	4.5 m	UV 20.4	UV 20.4	
2	9.0 m	UV 20.4	UV 20.4	
3	13.5 m	UV 20.4	UV 20.4	
4	18.0 m	UV 20.4	UV 20.4	
5	22.5 m	UV 20.4	UV 20.4	
6	27.0 m	UV 20.4	UV 20.4	
7	31.5 m	UV 20.4	UV 20.4	
8	36.0 m	TVA 20.4	TVA 20.4	
9	40.5 m	TV 20.4	TV 20.4	
10	45.0 m	TV 20.4	TV 20.4	
11	49.5 m	TV 20.4	TV 20.4	
12	54.0 m	TV 20.4	TV 20.4	
13	58.5 m	TV 20.4	TV 20.4	
14	59.5 m	VR 2023	VR 2023	
15	64.0 m	TV 23	TV 23	
16	68.5 m	HTA 23	HTA 23	
17	73.0 m	HT 23	HT 23	
18	77.5 m		HT 23	
Substructure		KRF6 12-60/80	KRF 16-80/100	
Corner distance [m x m]		8.0 x 8.0	10.0 x 10.0	
Substructure height [m]		2.9	3.3	
Tower height [m]		75.9	80.8	
Hook height double reeving [m]		77.4	82.3	
Hook height 4 fall operation [m]		77.0	81.9	
Wind category		C25		



3.5 Tower combinations on undercarriage (slewing section with UV20/TV20 - connection)

Jib length	30 m – 65 m				
Item					
1	4.5 m	UV 20.4	UV 20.4	UV 20.4	UV 20.4
2	9.0 m	UV 20.4	UV 20.4	UV 20.4	UV 20.4
3	13.5 m	UV 20.4	TVA 20.4	UV 20.4	UV 20.4
4	18.0 m			UV 20.4	UV 20.4
5	22.5 m			TVA 20.4	UV 20.4
6	27.0 m				UV 20.4
7	31.5 m				UV 20.4
8	36.0 m				UV 20.4
9	40.5 m				TVA 20.4
Substructure		UW 260.1	UW 260.2	UW 260.2	UW 260.3
Corner distance [m x m]		6.0 x 6.0	5.0 x 6.79	6.0 x 6.0	5.0 x 6.79
Substructure height [m]		4.5	4.5	4.5	4.5
Tower height [m]		18.0	18.0	27.0	45.0
Hook height double reeving [m]		19.5	19.5	28.5	46.5
Hook height 4 fall operation [m]		19.1	19.1	28.1	46.1
Wind category		C25			

3 Tower combinations

Jib length	30 m – 65 m			
Item				
1	4.5 m	UV 20.4	UV 20.4	
2	9.0 m	UV 20.4	UV 20.4	
3	13.5 m	UV 20.4	UV 20.4	
4	18.0 m	UV 20.4	UV 20.4	
5	22.5 m	UV 20.4	UV 20.4	
6	27.0 m	UV 20.4	UV 20.4	
7	31.5 m	UV 20.4	UV 20.4	
8	36.0 m	UV 20.4	TVA 20.4	
9	40.5 m	TVA 20.4	TV 20.4	
10	45.0 m	TV 20.4	TV 20.4	
11	49.5 m	TV 20.4	TV 20.4	
12	54.0 m		TV 20.4	
13	58.5 m		TVÜ 20.4	
14	63.0 m		UVA 25	
Substructure		UW 260.3	UW 480	
Corner distance [m x m]		6.0 x 6.0	8.0 x 8.0	
Substructure height [m]		4.5	5.0	
Tower height [m]		54.0	68.0	
Hook height double reeving [m]		55.5	69.5	
Hook height 4 fall operation [m]		55.1	69.1	
Wind category		C25		

4 Foundation loads / central ballast weights / corner loads in compliance with EN 14439 / EN 13001

	<div style="background-color: red; color: white; text-align: center; padding: 5px;">! DANGER</div> <p>Usage of incorrect tower combinations. The slewing tower crane may overturn.</p> <ol style="list-style-type: none"> 1) Use the specified tower combinations. 2) If you need another tower combination that is not specified here, please contact WOLFFKRAN to get an approved alternative setup in writing.
	<div style="background-color: #00a0e3; color: white; text-align: center; padding: 5px;">NOTICE</div> <p>If you need foundation loads for tower combination with tower element TV 25 and UV 25, please contact WOLFFKRAN to get an approved alternative setup.</p>

Jib positions

The corner loads are given for two jib positions with the maximum corner load resulting from jib position 1.

For square setup, the following equation is true: $a = b$

For rectangular setup, the following equation is true: $a > b$

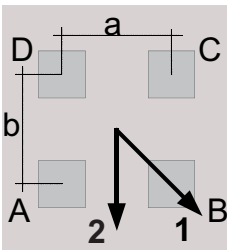

Cross frame or cross frame element

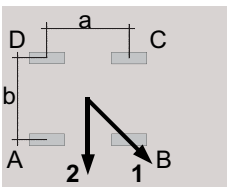

Undercarriage

NOTICE! For undercarriage details, please refer to the relevant operating manual.

Wind load with crane out of service

The stability for stormy weather is calculated on the basis of wind region C (EN 13001-2). The reference wind speed for zone C is 28 m/s (10 m above ground, averaged over 10 minutes). As a basis, a recurrence interval of 25 years is used. As a basis, a recurrence interval of 25 years is used.

4 Foundation loads / central ballast weights / corner loads in compliance with EN 14439 / EN 13001

Please contact WOLFFKRAN for stability calculations in other wind regions.

	NOTICE
	The 4 fall hook height is only for the crane 6531.12 <i>cross</i> in 4 fall operation.

For information on the different substructures, refer to Section 5 of the Operating Manual.

4.1 Foundation loads jib 30 m - 65 m

Slewing section 6531 cross with 30 m – 65 m jib on foundation.
Slewing tower crane without climbing device.

Foundation load in compliance with EN 14439 / EN 13001 – typical loads

Includes all dynamical factors under consideration of second-order theory for stationary slewing tower cranes on concrete foundation in compliance with a tower combination without climbing device.

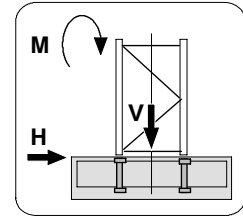

HH		Crane in service			Crane out of service			Assembly		
4	2	Slewing torque: 320 kNm			Wind category C25					
STR	STR	M	V	H	M	V	H	M	V	H
[m]	[m]	[kNm]	[kN]	[kN]	[kNm]	[kN]	[kN]	[kNm]	[kN]	[kN]
5.6	6.0	2070	460	19	1890	460	37	2590	373	7
10.1	10.5	2160	479	20	2070	479	42	2630	391	8
14.6	15.0	2270	497	22	2280	497	46	2680	409	9
19.1	19.5	2380	515	23	2510	515	51	2730	427	10
23.6	24.0	2510	533	25	2780	533	56	2800	445	11
28.1	28.5	2650	551	27	3070	551	61	2870	464	12
32.6	33.0	2810	570	28	3390	570	65	2960	482	12
37.1	37.5	2980	588	29	3750	588	70	3050	500	13
41.6	42.0	3170	606	31	4150	606	75	3160	518	14
46.1	46.5	3540	754	36	4590	624	80	3280	536	15
50.6	51.0	3720	803	39	5300	754	100	3350	585	17
55.1	55.5	3980	831	41	5860	782	106	3470	613	18
59.6	60.0	4370	967	43	6480	810	112	3610	641	19
64.1	64.5	4710	995	45	7820	1050	170	3760	670	20
68.6	69.0	5090	1024	47	8170	997	165	3920	698	21
69.6	70.0	5040	1067	48	8250	1041	171	3900	742	22
74.1	74.5	5370	1107	51	9420	1080	182	4050	781	23
78.6	79.0	5740	1146	53	10700	1119	194	4220	821	24
80.9	81.3	5880	1181	54	11280	1155	201	4280	856	25
85.4	85.8	6290	1221	56	12730	1194	213	4460	895	26
Tower combination with base tower element BT 29										
89.8	90.2	6540	1284	59	14000	1258	227	4580	959	28
94.3	94.7	6950	1330	62	15600	1304	241	4760	1005	29

Caption

HH:	Hook height	M:	Torque	H:	Horizontal load
STR:	Number of falls	V:	Vertical load		



5 Operating speeds

5 Operating speeds

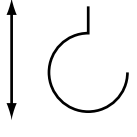
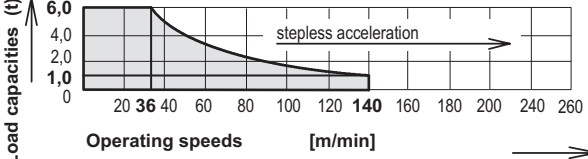
WOLFF 6531.12cross

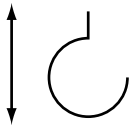
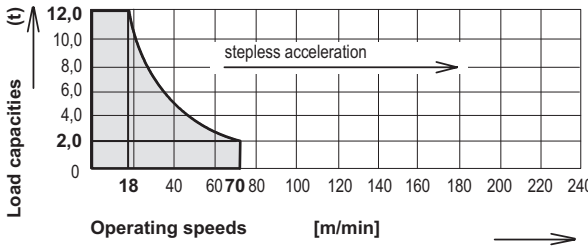
Drive unit [type]	Operating speed Carrying load		Hook travel distance max. [m]	Power [kW]	Total connected wattage [kVA]
Hw645FU	Lifting / lowering		190	45	68.0 Total connected load at coincidence factor of 0.8
					

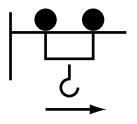
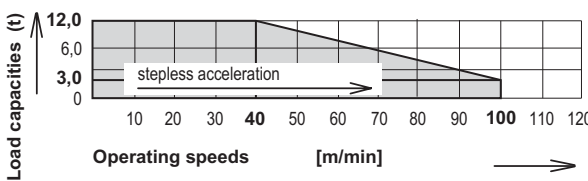

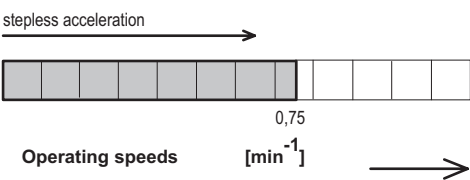
Drive unit [type]	Operating speed Carrying load		Hook travel distance max. [m]	Power [kW]	Total connected wattage [kVA]
Hw645FU	Lifting / lowering		95	45	68.0 Total connected load at coincidence factor of 0.8
					

KW	Trolley movement	9.0	
			
SG	Slewing	2x6.0	
			

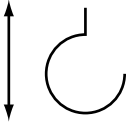
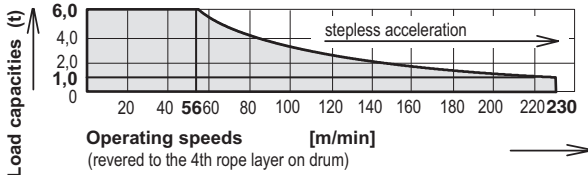
WOLFF 6531.12cross

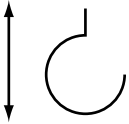
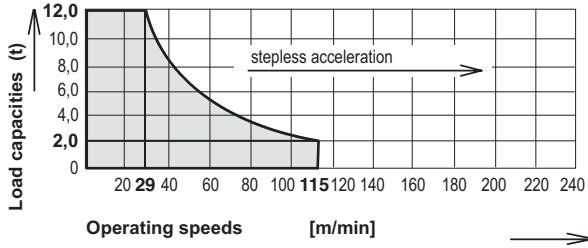
Drive unit [type]	Operating speed Carrying load		Hook travel distance max. [m]	Power [kW]	Total connected wattage [kVA]
Hw675FU	Lifting / lowering		460	75	96.0 Total connected load at coincidence factor of 0.8
	 <p>Operating speeds [m/min] (reversed to the 4th rope layer on drum)</p>				

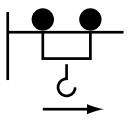
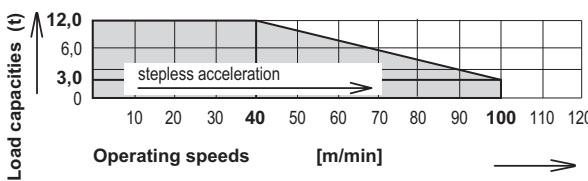
Drive unit [type]	Operating speed Carrying load		Hook travel distance max. [m]	Power [kW]	Total connected wattage [kVA]
Hw675FU	Lifting / lowering		230	75	96.0 Total connected load at coincidence factor of 0.8
	 <p>Operating speeds [m/min]</p>				

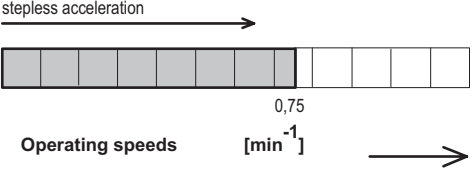

KW	Trolley movement		9.0	
	 <p>Operating speeds [m/min]</p>			
SG	Slewing		2x6.0	
	 <p>Operating speeds [min⁻¹]</p>			

5 Operating speeds

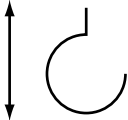
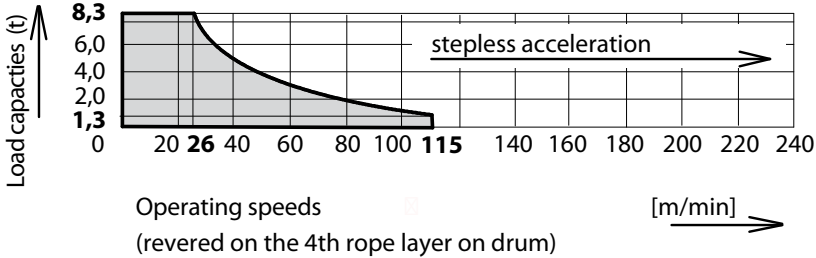
WOLFF 6531.12cross

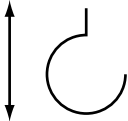
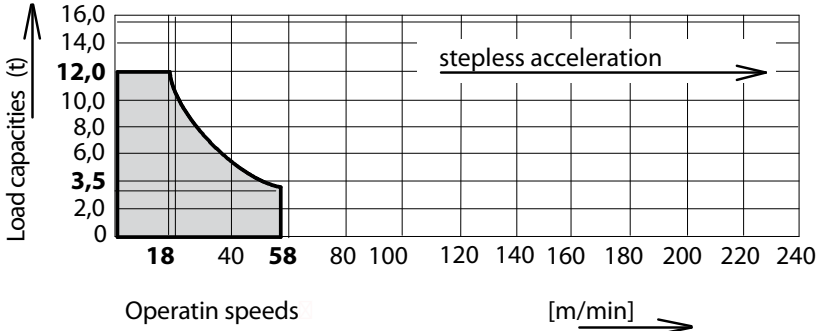
Drive unit [type]	Operating speed Carrying load		Hook travel distance max. [m]	Power [kW]	Total connected wattage [kVA]
Hw845FU	Lifting / lowering		190	45	68.0 Total connected load at coincidence factor of 0.8
	 <p>Operating speeds (reversed on the 4th rope layer on drum)</p>				

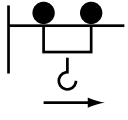
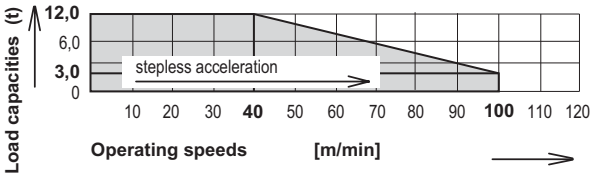
Drive unit [type]	Operating speed Carrying load		Hook travel distance max. [m]	Power [kW]	Total connected wattage [kVA]
HW845FU	Lifting / lowering		95	45	68.0 Total connected load at coincidence factor of 0.8
	 <p>Operatin speeds</p>				

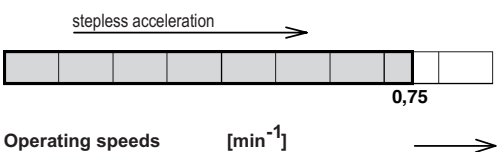





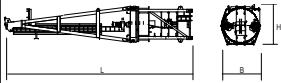
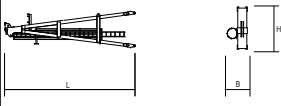
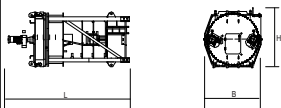
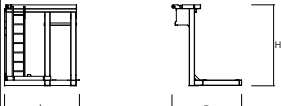
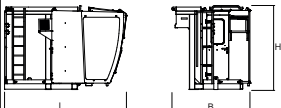
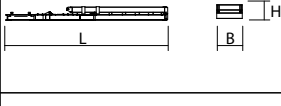
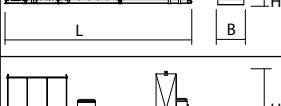
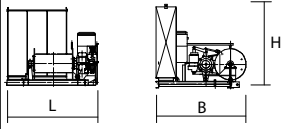
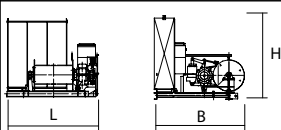
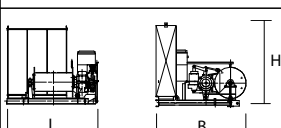
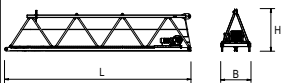
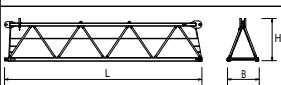

KW	Trolley movement		9.0
	 <p>Operating speeds [m/min]</p>		
SG	Slewing		2x6.0
	 <p>Operating speeds [min⁻¹]</p>		

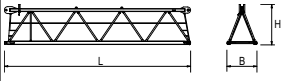
6 Package list

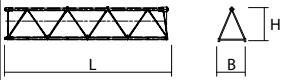
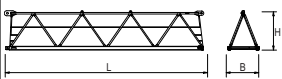
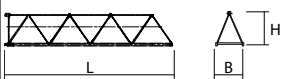
6.1 Package list 6531.12

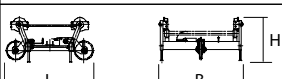
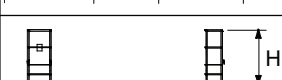
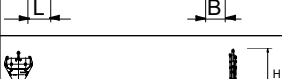
Quantity	Description	Package	L [m]	W [m]	H [m]	Weight [kg]	Volume [m ³]
1	Tower head section, complete including platforms and misc. stay parts		11.72	2.42	2.42	10830	68.64
	Tower head section upper part including platforms and misc. stay parts		7.45	1.37	2.42	2730	24.70
	Tower head section lower part including slewing frame, ball slew bearing, slewing gears and slip ring system		5.39	2.42	2.42	8100	31.57
1	Driver's cab suspension		2.14	1.95	2.42	680	10.10
1	Driver's cab with driver's cab suspension		3.57	2.29	2.42	1700	19.78
1	Counterjib in hinged position (stay parts)		12.40	2.49	1.05	4700 (430)	32.29
	Counterjib (stay parts)		16.34	2.49	0.65	4700 (430)	26.45
1	Machine platform Hw645FU including hoisting rope (Ø 16 mm x 280 m)		2.48	2.46	2.18	3170	13.30
1	Machine platform Hw675FU including hoisting rope (Ø 16 mm x 280 m)		2.48	2.46	2.18	3500	13.30
1	Machine platform Hw845FU including hoisting rope (Ø 16 mm x 280 m)		2.48	2.46	2.18	3270	13.30
1	Jib element 1 with traverse gear		10.16	1.64	2.30	2960	38.32
1	Jib element 2		10.27	1.64	2.05	1810	34.53

6 Package list

Quantity	Description	Package	L [m]	W [m]	H [m]	Weight [kg]	Volume [m ³]
1	Jib element 3		10.27	1.64	2.05	1725	34.53
1	Jib element 5		5.26	1.64	2.02	1000	17.43
1	Jib element 6		10.24	1.64	2.01	1700	33.76
1	Jib element 7		10.22	1.64	2.00	1260	33.52
1	Jib element 8		10.20	1.64	2.00	1010	33.46
1	Rope swivel cross-beam		1.05	1.54	0.47	135	0.76
1	Trolley LK 6/12		1.87	1.85	0.99	410	3.43
	Maintenance cage		0.75	0.58	1.69	55	0.74
1	Hook block U 6/12 (U 8/16) (Loose part)		1.02	0.26	1.70	560	0.45
1	Brace rods		10.12	0.56	0.36	1480	2.04
	Standard railings		2.60	1.10	0.65	300	1.86
1	Box (small parts)		0.63	0.50	0.38	100	1.12

7 Assembly weights

7.1 Counterweight blocks



NOTICE

The described diagrams of the concrete counterweights and central ballast blocks only show sketches. Have them issue the reinforcement charts by experts.

7 Assembly weights

7.1.1 Counterweight block, 2.0 t

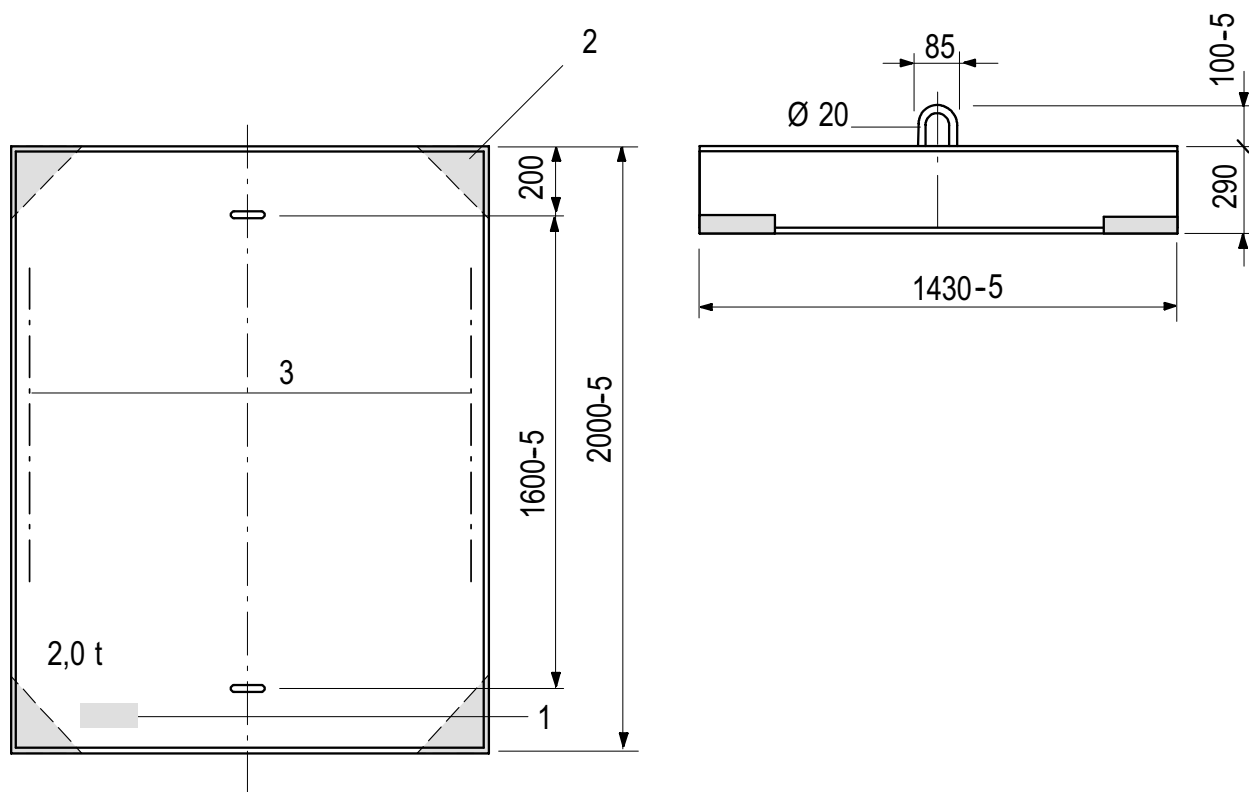

Data counterweight block 2.0 t

Item	Data
Material	Concrete, min. C 20/25
Max. permitted weight tolerance	+/- 3 %
Order number	962-2-006590
1	Component identifier
2	Corner guard
3	Structural steel reinforcement

7.1.2 Counterweight block, 2.7 t

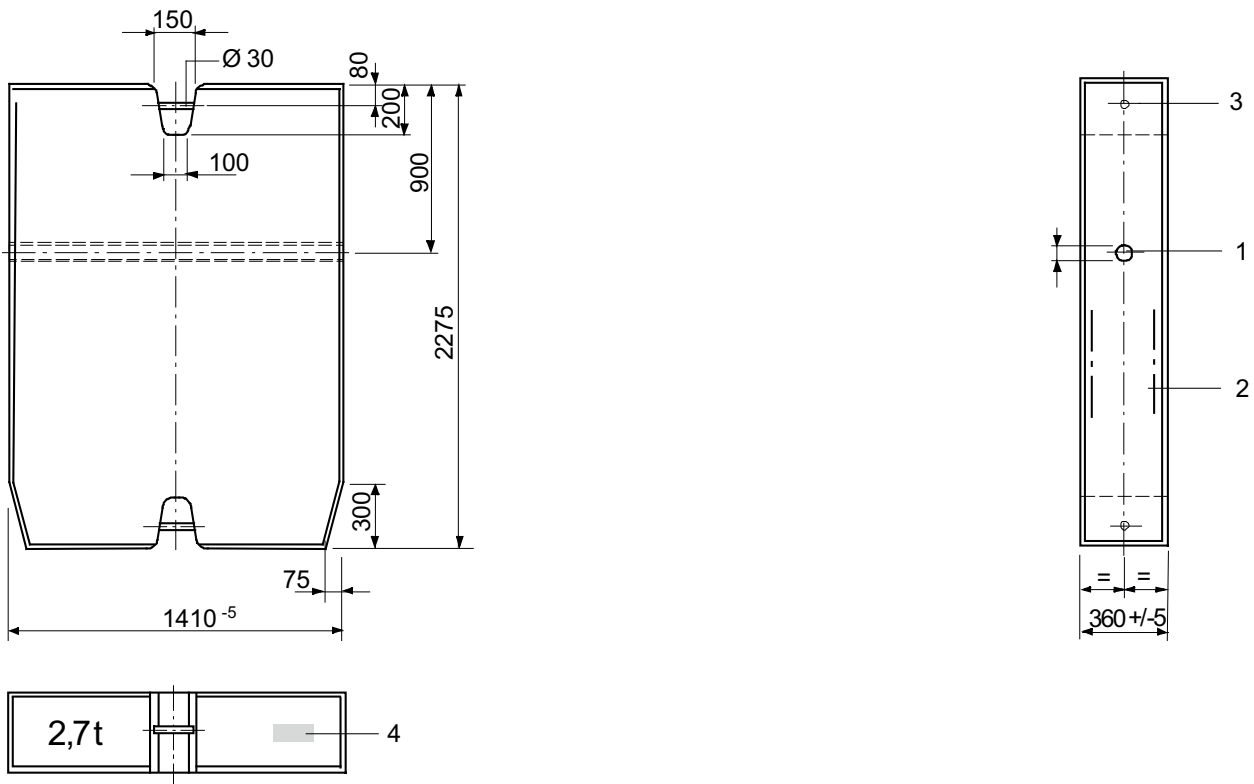

Data counterweight block 2.7 t

Item	Data
Material	Concrete, min. C 20/25
Max. permitted weight tolerance	+/- 3 %
Order number	30021887
1	Connection for stub shaft (Ø 40x 215 Item no.: 30024871)
2	Structural steel reinforcement
3	Suspension
4	Component identifier

7 Assembly weights

7.2 Total weight jib assembly

Assembly weights 6531

Trolley jib, complete: Brace plates, crab, trolley drive rope, snatch block and standard railings

Jib length [m]	Weight [kg] WOLFF 6531
65.0	13885
60.0	12885
55.0	12875
50.0	11875
45.0	11615
40.0	10615
35.0	9915
30.0	8915

7.3 Assembly weight slewing section

Module	Crane parts	Weight [kg]	
Tower head section complete (including brace plates, driver's cab, driver's cab suspension, platform and standard railings)			12530
	▪ Driver's cab with driver's cab suspension	1700	
	▪ Tower head section lower part including slewing frame, ball race bearing, slewing gears, standard railings and slip ring system	8100	
	▪ Tower head section upper part complete	2730	
Counterjib with Hw645FU			10170
	▪ Counterjib with 4 brace plates and standard railings	5000	
	▪ Machine platform Hw645FU including hoisting rope (Ø 16 mm x 280 m)	3170	
	▪ Counterweight 2 t (below machine platform)	2000	
Counterjib with Hw675FU			10500
	▪ Counterjib with 4 brace plates and standard railings	5000	
	▪ Machine platform Hw675FU including hoisting rope (Ø 16 mm x 280 m)	3500	
	▪ Counterweight 2t (below machine platform)	2000	
Counterjib with Hw845FU			10270
	▪ Counterjib with 4 brace plates and standard railings	5000	
	▪ Machine platform Hw845FU including hoisting rope (Ø 16 mm x 280 m)	3270	
	▪ Counterweight 2 t (below machine platform)	2000	

7 Assembly weights

7.4 Assembly weight cross frame

Module	Crane part	Weight [kg]	
Cross frame KR 16-46/60 (without accessories)			7000
(4.6m x 4.6m)	▪ 4 bolted spigots AZR 120 E 15.5	560	
	▪ 4 bolted spigots AZ 140 M	684	
Cross frame KR 16-46/60 (without accessories)			8805
(6.0m x 6.0m)	▪ 4 bolted spigots AZR 120 E 15.5	560	
	▪ 4 bolted spigots AZ 140 M	684	
Cross frame KR 1000-8			14630
	▪ 4 bolted spigots AZ 140 E	684	
	▪ 4 bolted spigots AZ 156 M	748	
Cross frame KR 16-80/ 100 (without accessories)			21450
(8.0m x 8.0m)	▪ 4 bolted spigots AZ 140 E KR 16-80	620	
	▪ 4 bolted spigots AZ 156 M KR 16-80	680	
	▪ 4 bolted spigots AZ 156S M KR 16-80	675	
Cross frame KR 16-80/ 100 (without accessories)			25400
(10.0m x 10.0m)	▪ 4 bolted spigots AZ 140 E KR 16-80	620	
	▪ 4 bolted spigots AZ 156 M KR 16-80	680	
	▪ 4 bolted spigots AZ 156S M KR 16-80	675	

7.5 Assembly weights traveling cross frame

Module	Crane parts	Weight [kg]	
Mobile cross frame KRF 10 – 46/60 complete			17500
(6.0 m x 6.0 m)	▪ Cross frame	7000	
	▪ Drive gear corners	2385	
	▪ Backing braces	1510	
	▪ Subframe	5645	
	▪ Platforms + ladders	510	
	▪ Control cabinet	130	
	▪ small items	320	
	▪ Set of bolted spigots AZR 120 E 15,5 KRF 10-46/60	605	
	▪ Set of bolted spigots AZR 140 M KRF 10-46/60	760	
Traveling cross frame KRF4 12-60/80 complete			32300
(8.0 m x 8.0 m)	▪ Cross frame	14170	
	▪ Backing braces	2875	
	▪ Drive gear corners	4560	
	▪ Subframe	9380	
	▪ Platforms and ladders	255	
	▪ Control cabinet	130	
	▪ small items	930	
	▪ Set of bolted spigots AZR 140 M KR 12-60/80	790	
	▪ Set of bolted spigots AZ 120 E 15,5 KR 12-60/80	730	
	▪ Set of bolted spigots AZ 140 E 15,5 KR 12-60/80	875	
	▪ Set of bolted spigots AZR 160 M KR 12-60/80	905	
	▪ Set of bolted spigots AZ 140 E 10 KR 12-60/80	790	
	▪ Set of bolted spigots AZR 156 M KR 12-60/80	845	
Traveling cross frame KRF6 12-60/80 complete			41200
(8.0 m x 8.0 m)	▪ Cross frame	14170	
	▪ Backing braces	2875	
	▪ Drive gear corners	4560	
	▪ Subframe	18270	
	▪ Platforms and ladders	255	
	▪ Control cabinet	130	
	▪ small items	940	
	▪ Set of bolted spigots AZR 140 M KR 12-60/80	790	

7 Assembly weights

Module	Crane parts	Weight [kg]
	▪ Set of bolted spigots AZ 120 E 15,5 KR 12-60/80	730
	▪ Set of bolted spigots AZ 140 E 15,5 KR 12-60/80	875
	▪ Set of bolted spigots AZR 160 M KR 12-60/80	905
	▪ Set of bolted spigots AZ 140 E 10 KR 12-60/80	790
	▪ Set of bolted spigots AZR 156 M KR 12-60/80	845

7.6 Assembly weight cross frame elements

Module	Crane parts	Weight [kg]	
Cross frame element KRE 260.1, complete			8100
	▪ Cross frame platform with hinged section, corner plates and transport locks	4320	
	▪ Mast base with diagonal struts and tie rods	3780	
Cross frame element KRE 260.2, complete			10900
	▪ Cross frame platform with hinged section, corner plates and transport locks	5455	
	▪ Mast base with diagonal struts and tie rods	5445	
Cross frame element KRE 480 complete			24250
	▪ Mast base	7100	
	▪ Hinged sections with corner plates	6250	
	▪ Diagonal struts and ballast carrier	9260	
	▪ Assembly platform, ladder, and small parts	1640	

7 Assembly weights

7.7 Assembly weight undercarriage

Module	Crane parts	Weight [kg]	
Undercarriage UW 260.1, complete			11400
	▪ Undercarriage platform with hinged sections, subframes and transport locks	7150	
	▪ Mast base with diagonal struts and tie rods	4250	
Undercarriage UW 260.2, complete			13930
	▪ Undercarriage platform with hinged sections, subframes and transport locks	8050	
	▪ Mast base with diagonal struts and tie rods	5880	
Undercarriage UW 260.3, complete			17200
	▪ Undercarriage platform with hinged sections, subframes and transport locks	11300	
	▪ Mast base with diagonal struts and tie rods	5900	
Undercarriage UW 480, complete			34000
	▪ Mast base including control cabinet	7100	
	▪ Hinged sections with mounting device and subframes	16000	
	▪ Diagonal struts and ballast carrier	9260	
	▪ Assembly platform, ladder, and small parts	1640	

7.8 Required hook height for mobile cranes

For information about the height of the WOLFF slewing tower crane, refer to Tower combinations [16].

NOTICE! During assembly, allowances must be made for level differences (mobile crane to base of the slewing tower crane).

Hook height above ground required for mobile cranes (X) = height of the WOLFF slewing tower crane (A) + clearance of 15 m (B).

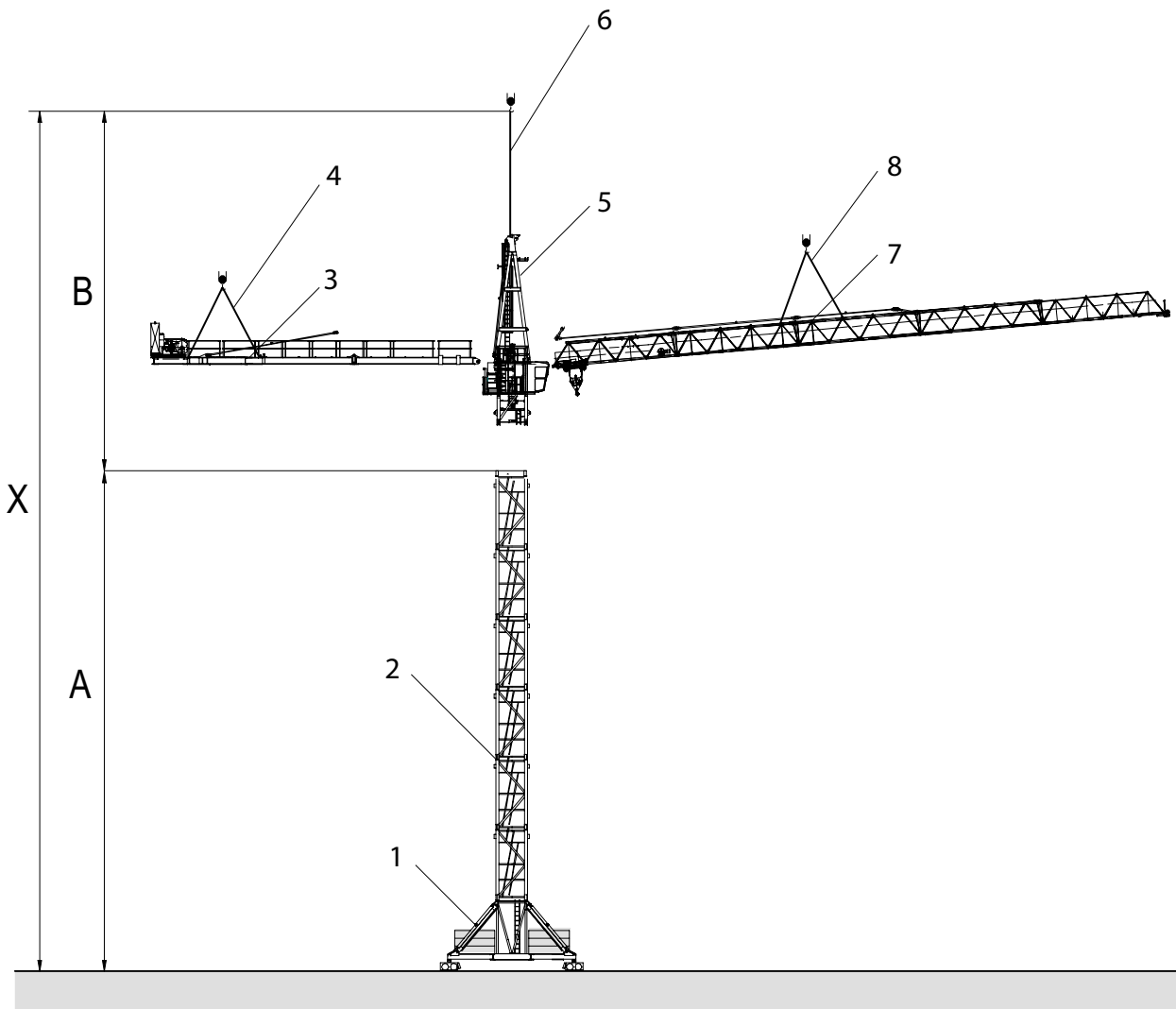

Exemplary illustration

[A]	Height of the WOLFF slewing tower crane	[B]	Clearance 15 m
[X]	Hook height above ground required for the mobile crane		
1	Substructure	5	Tower head section, complete
2	Tower element	6	Single-point lifting tackle (1 m with shackle)
3	Counterjib including hoisting winch platform	7	Jib, complete
4	Four-point lifting tackle (6 m with shackle)	8	Four-point lifting tackle (6 m with shackle)

7 Assembly weights

(see also):

- Tower combinations [\[16\]](#)

8 Assembly diagrams

8.1 Jib attachment diagram

	NOTICE
	For jib assembly, use a Four-point lifting tackle (6 m with shackle).

Length of jib elements

Item	Length [m]
Jib element 1, 2, 3, 6, 7, 8	10.0
Jib element 5	5.0

8 Assembly diagrams

8.1.1 Trolley jib - attachment diagram 2 / 4 fall operation

8.1.1.1 Trolley jib - attachment diagram 65 m to 50 m

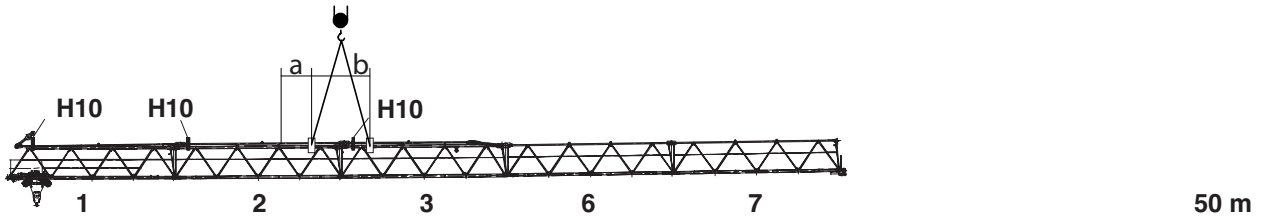
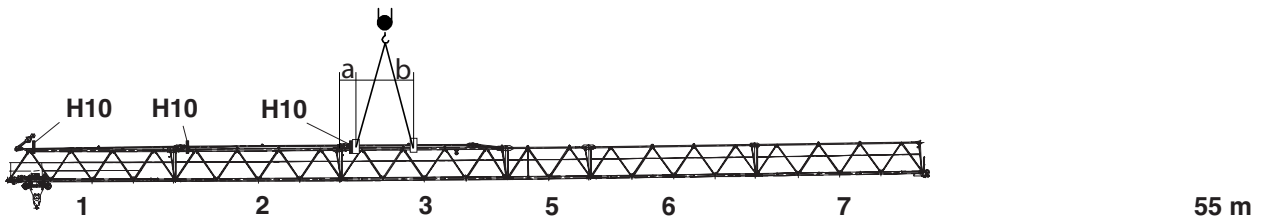
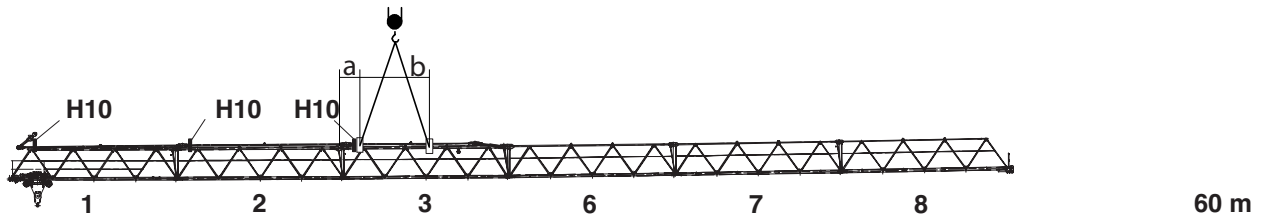
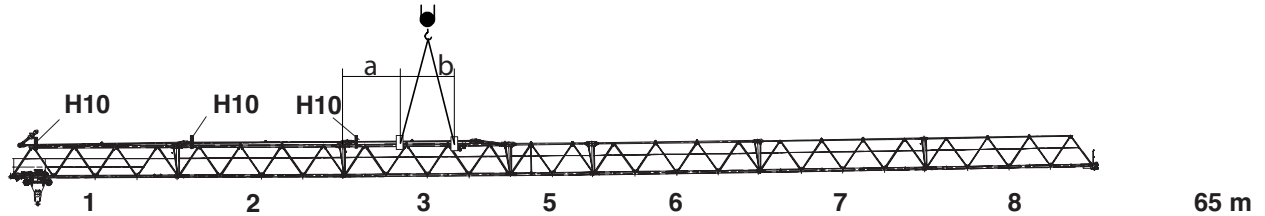

a	Dimension a	H10	Mounting rig H10
b	Dimension b		

Attachment data 6531 cross

Data	Jib length [m]			
	65.0	60.0	55.0	50.0
a [m]	3.59	1.09	1.09	1.42
b [m]	3.01	4.15	3.01	1.60
Weight [kg]	13885	12885	12875	11875

8.1.1.2 Trolley jib - attachment diagram 45 m to 30 m

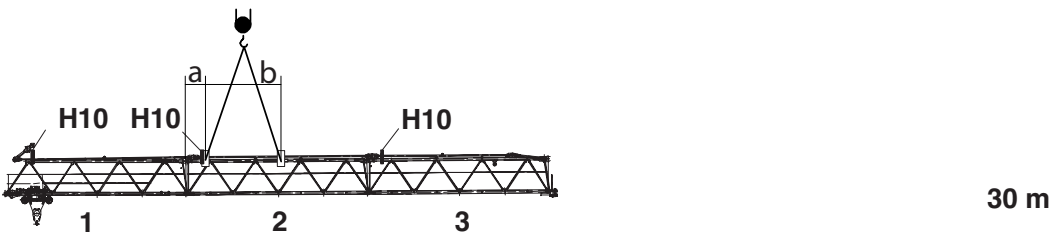
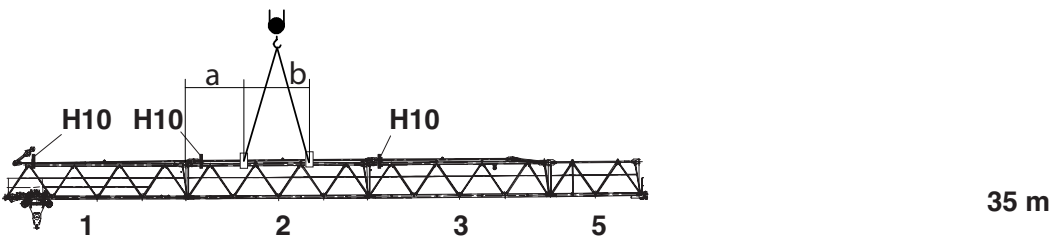
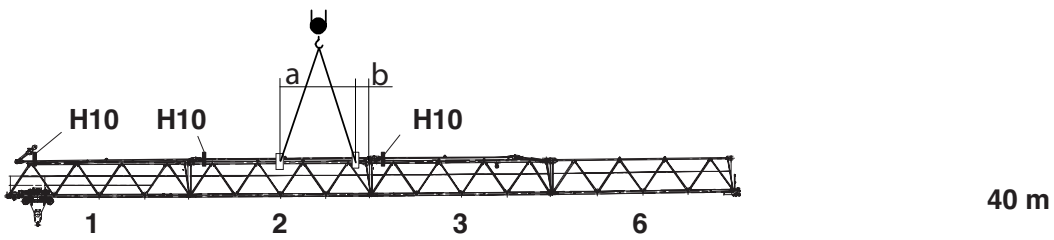
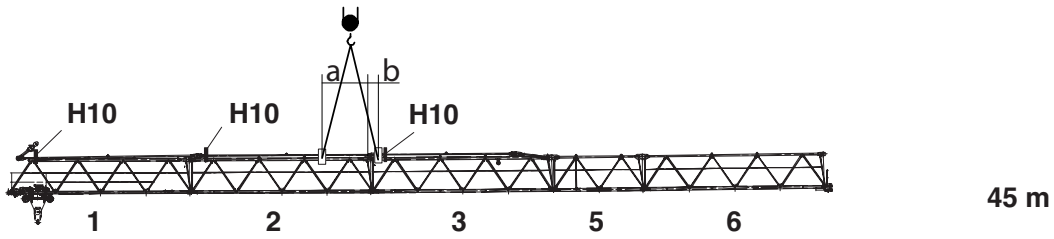

a	Dimension a	H10	Mounting rig H10
b	Dimension b		

Attachment data 6531 cross

Data	Jib length [m]			
	45.0	40.0	35.0	30.0
a [m]	2.55	4.15	3.58	1.08
b [m]	0.54	0.90	3.02	4.16
Weight [kg]	11615	10615	9915	8915

8 Assembly diagrams

8.2 Jib brace diagram

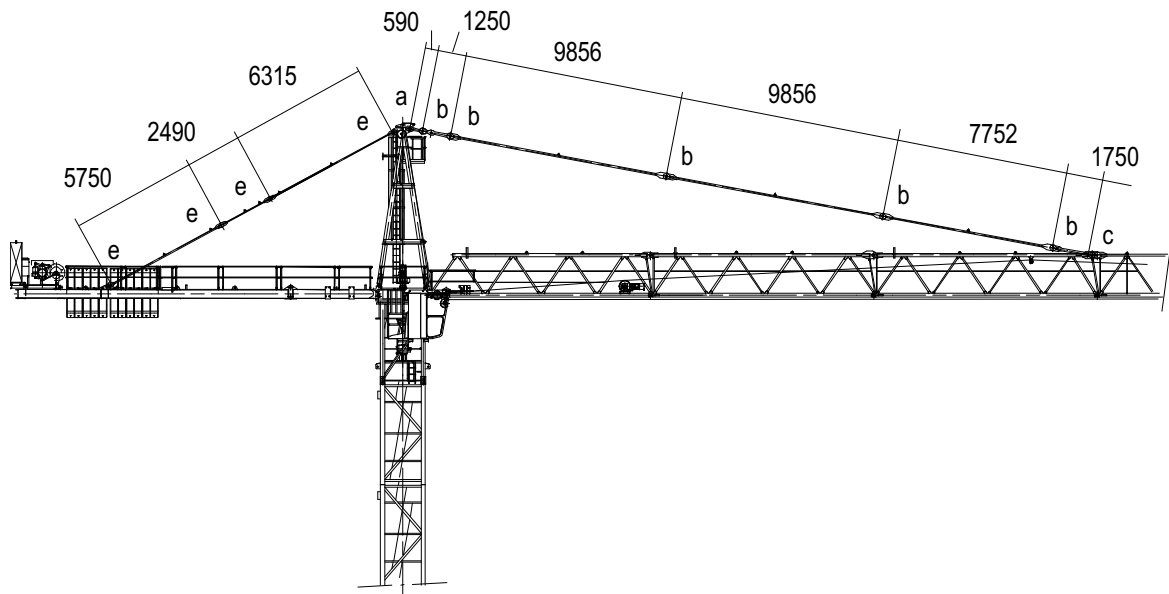

Bolt table

Jib length	Item	Bolts		Fuse	
		Quantity	Dimension [mm]	Quantity	Dimension [mm]
Jibs - all	a	1	Ø 100/90x225	1	Spring retainers Ø10/60-80, steel galvanized, yellow
	b	5	Ø 80/70x180	5	Spring retainers Ø10/60-80, steel galvanized, yellow
	c	1	Ø 80/70x272	1	Axle retainer 40x10x140
				2	Hex. screws M16 x 30 ISO 4017-8.8 galv.
				2	Lock washer A 16 DIN 127 Fed.steel, galvanized
Counterjib	e	8	Ø 70/60x150	8	Spring retainers Ø10/60-80, steel galvanized, yellow

8.3 Trolley jib mounting rig

	NOTICE
	<p>For information on the arrangement of the mounting rig, refer to the attachment diagram.</p> <p>Two mounting rigs are required per slewing tower crane.</p>

Elements required for each mounting rig

Quantity	Item	Dimensions	Material
1	Mounting rig		
4	Hexagonal head bolt	M16 x 220	ISO 4014-8.8 galv.
4	HSFG washer	17	EN 14399 galvanized
4	Hexagonal nut	M16	ISO 4032-8 galvanized
4	Hexagonal nut	M16	DIN 7967, galvanized

Mounting rig

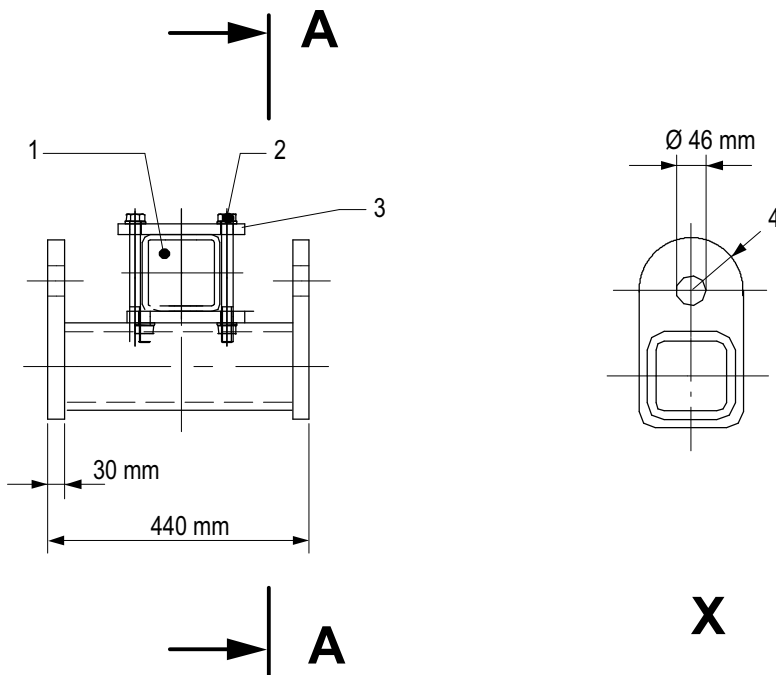

1	Top chord trolley jib	4	Radius 65 mm
2	Hexagonal head screw	A	Section A-A
3	Metal plate 12x240x240	X	View section A-A

8 Assembly diagrams

8.4 Mounting rig for trolley jib

	NOTICE		
	<p>For information on the arrangement of the mounting rig, refer to the attachment diagram. For information on the arrangement of the mounting rig, refer to the attachment diagram.</p> <p>Two mounting rigs are required per slewing tower crane.</p>		

Dimensions for mounting rig

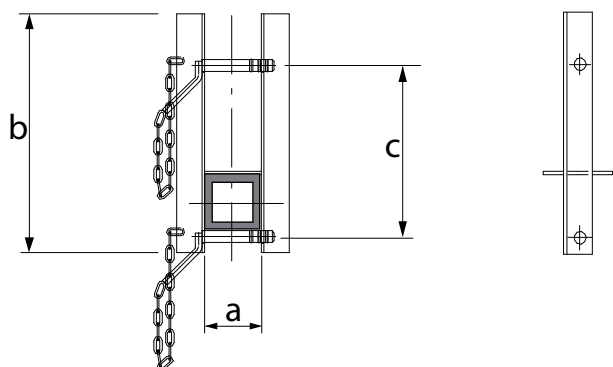

Mounting rig H10

Type	Dimensions		
	a [mm]	b [mm]	c [mm]
H10	144	450	312

8.5 Arrangement of standard railings

8.5.1 Standard railings (NG) and accessories

Arrangement of standard railings Hw645FU / Hw845FU

Quantity	Standard railings (NG)/ accessories	Dimensions / spacing of posts / height
4	Standard posts (NP)	–
1	Standard posts with holder (NPF)	–
1	Flagpole holder (F*)	1400 mm
1	NGE 300	–
1	Standard railing 350	200 mm
5	Standard railing 500	400 mm
4	Standard railing 750	600 mm
7	Standard railing 1000	900 mm
5	Standard railing 1500	1400 mm
5	Standard railing 2000	1900 mm
8	Standard railing 2500	2400 mm
1	RS (hoop guard)	–
1	Support block AB 1	700 mm
1	Support block AB 2	1400 mm

8 Assembly diagrams

8.5.2 Arrangement of standard railings

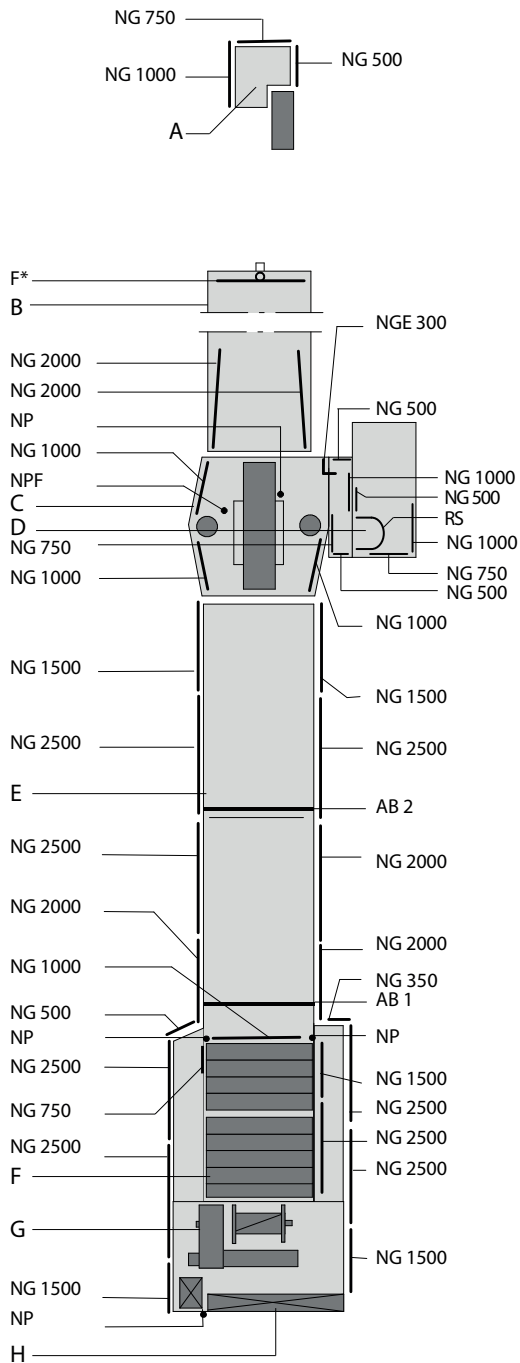



Arrangement of standard railings counterjib with Hw645FU or Hw845FU

A	Cat head pedestal	E	Counterjib
B	Trolley jib	F	Counterweights
C	Slewing frame	G	Machine platform
D	Driver's cab	H	Control cabinet

9 Suitable climbing devices



This section contains information on

- Outer climbing devices (KWH)
- Inner climbing devices (KSH)

	<p style="text-align: center;">NOTICE</p> <p>Details on the climbing device Always refer to the details in the documentation of the climbing device.</p>
	<p style="text-align: center;">NOTICE</p> <p>The operating radius specified is measured from the tower center and is to be considered a reference value. Exact balancing can be achieved by changing the operating radius with the tower elements or loads specified in the table.</p>
	<p style="text-align: center;">NOTICE</p> <p>If feasible, preferably operate your climbing device without balancing weight.</p>

9 Suitable climbing devices

9.1 Outer climbing devices

	<p style="text-align: center;">! DANGER</p> <p>Climbing device attached to the lower part of the tower head section lower part.</p> <p>Increased wind surface. The slewing tower crane may overturn.</p> <ul style="list-style-type: none">▶ Dismantle the climbing device after the climbing procedure is finished or lower the climbing device down on the ground or lower the climbing device down to the uppermost tower brace.
	<p style="text-align: center;">NOTICE</p> <p>Tower element on the transfer carriage</p> <p>The data on climbing balance was specified under the assumption that a tower element is on the transfer carriage.</p>

9.1.1 Outer climbing device KWH 20.3 / KWH 20.3.1

Climbing radius [m] for the balancing weights

6531.12	Jib length [m]							
	65	60	55	50	45	40	35	30
UV 20.4 = 2.05 t	22.5	29.2	31.9	28.9	33.5	-	-	-
TV 20.4 = 2.98 t	16.2	21.4	23.5	21.2	24.7	26.9	28.1	-
Weight = 5.00 t	-	-	-	-	-	-	18.4	19.5

9 Suitable climbing devices

9.1.2 Outer climbing device KWH 20.6 / KWH 20.6.1 / KWH 20.6.2

NOTICE! The assembly of the climbing gear for the slewing tower crane 6531cross takes place in 4 fall operation.

Climbing radius [m] for the balancing weights

6531.12	Jib length [m]							
	65	60	55	50	45	40	35	30
UV 20.4 = 2.05 t	21.7	28.5	31.2	28.2	32.7	-	-	-
TV 20.4 = 2.98 t	15.7	20.9	23.0	20.6	24.1	26.4	27.5	-
Weight = 5.00 t	-	-	-	-	-	-	18.0	19.2

9.2 Inner climbing devices

	NOTICE
	The data required and the instructions for tower assemblies with inner climbing device is available in the separate description of the inner climbing device.

DANGER! Observe the special tower combination for the inner climbing device.

	NOTICE
	Clamping forces for the inner climbing device (KSH) are specified based on a building height of < 250m and wind category C 25.

9 Suitable climbing devices

9.2.1 Inner climbing device KSH 20 SH

Tower combinations for slewing tower cranes with inner climbing device.

Item				
1	UV 20.4	UV 20.4	UV 20.4	UV 20.4
2	UV 20.4	UV 20.4	UV 20.4	UV 20.4
3	UV 20.4	UV 20.4	UV 20.4	UV 20.4
4	UV 20.4	UV 20.4	UV 20.4	UV 20.4
5	UV 20.4	UV 20.4	UV 20.4	UV 20.4
6	UV 20.4	UV 20.4	UV 20.4	UV 20.4
7	TVA 20.4	TVA 20.4	TVA 20.4	TVA 20.4
8		TV 20.4	TV 20.4	TV 20.4
9			TV 20.4	TV 20.4
10				TV 20.4
inner climbing device	KSH 20 SH	KSH 20 SH	KSH 20 SH	KSH 20 SH
Foundation anchors	FUA TYPE FS-156 / FUA 156S	FUA TYPE FS-156 / FUA 156S	FUA TYPE FS-156 / FUA 156S	FUA TYPE FS-156 / FUA 156S
Tower height [m]	46.5	51.0	55.5	60.0
Hook height (2 fall operation) [m]	48.0	52.5	57.0	61.5
Hook height (4 fall operation) [m]	47.6	52.1	56.6	61.1

Climbing radius [m] for the balancing weights

6531.12	Jib length [m]							
	65	60	55	50	45	40	35	30
UV 20.4 = 2.05 t	52.0	-	-	-	-	-	-	-
TV 20.4 = 2.98 t	40.2	44.3	46.4	42.2	-	-	-	-
Weight = 5.00 t	-	-	-	-	30.5	31.3	31.4	-
Weight = 8.00 t	-	-	-	-	-	-	21.1	21.4

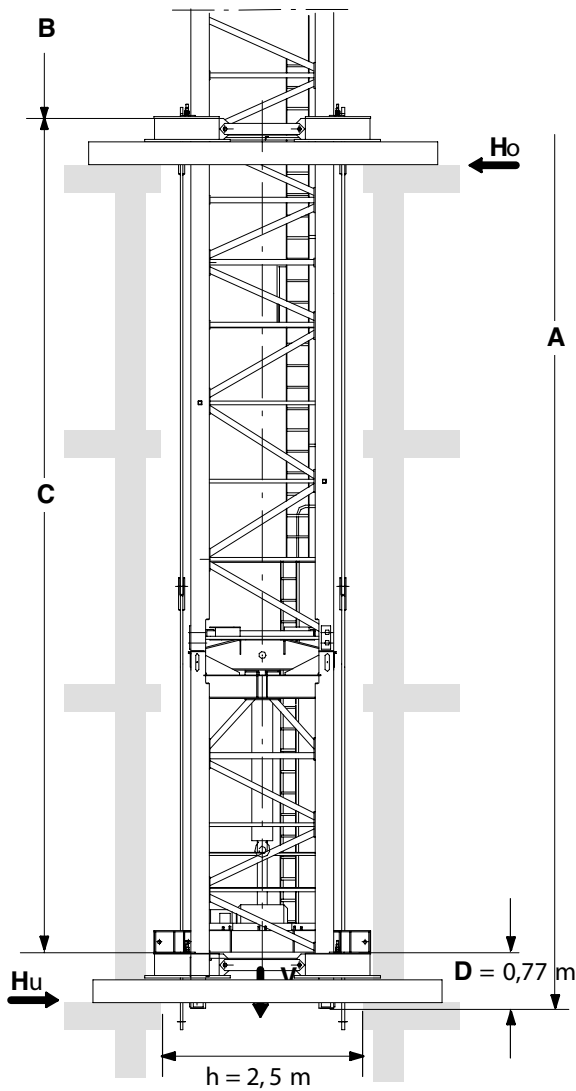

$$C_{\min} = 11,0 \text{ m}$$

$$C_{\max} = 14,0 \text{ m}$$

$$H_o = \frac{M}{C} + H$$

$$H_u = H_o - H$$

$$T = \frac{M_D}{2 \times b}$$

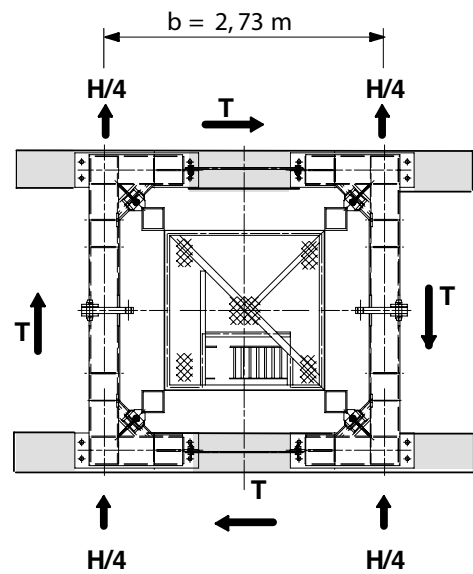

A	Tower height	C	Distance between guide frames
B	A-C-D		

9 Suitable climbing devices

In service clamping forces



In service clamping forces [kN] inside a building																	
A (m)	60.0				55.5				51.0				46.5				
C (m)	11.0	12.0	13.0	14.0	11.0	12.0	13.0	14.0	11.0	12.0	13.0	14.0	11.0	12.0	13.0	14.0	
V	1200				1172				1143				1115				
Ho	380	350	320	300	360	330	300	280	330	310	280	260	260	310	290	270	250
Hu	330	300	280	250	310	280	260	240	290	260	240	220	220	270	250	230	210
T	59				59				59				59				

Out of service clamping forces

Out of service clamping forces [kN] inside a building																	
A (m)	60.0				55.5				51.0				46.5				
C (m)	11.0	12.0	13.0	14.0	11.0	12.0	13.0	14.0	11.0	12.0	13.0	14.0	11.0	12.0	13.0	14.0	
V	1070				1041				1013				985				
Ho	820	750	700	650	720	660	610	570	630	580	530	490	490	540	500	460	430
Hu	570	500	450	400	490	430	380	330	400	350	310	270	270	330	290	250	220
T	-				-				-				-				

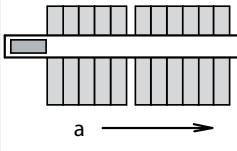
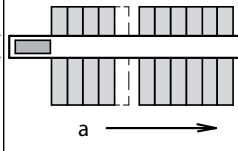
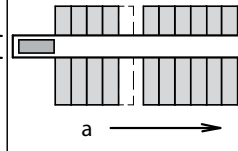
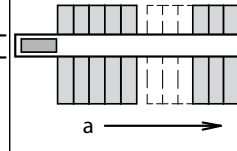
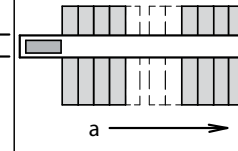
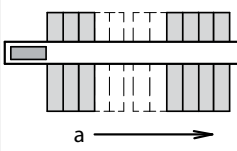
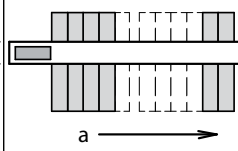
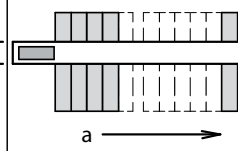
10 Arrangement of counterweight blocks

L = 65 m	L = 60 m	L = 55 m	L = 50 m	L = 45 m
11 x 2.7 t	10 x 2.7 t	10 x 2.7 t	8 x 2.7 t	8 x 2.7 t
				
W = 31.7 t	W = 29.0 t	W = 29.0 t	W = 23.6 t	W = 23.6 t
Permanent counterweight below machine platform = 2.0 t				
L = 40 m	L = 35 m	L = 30 m		
7 x 2.7 t	6 x 2.7 t	5 x 2.7 t		
				
W = 20.9 t	W = 18.2 t	W = 15.5 t		

	Counterweight block 1 x 2.7 t	L	Jib length [m]
	No counterweight	G	Total weight [t]
a	To the tower		

WOLFFKRAN Group

Headquarter international:

WOLFFKRAN AG

Baarermattstraße 6

CH-6300 Zug

Switzerland

Phone +41 41 766 85 00

Fax +41 41 766 85 99

info@wolffkran.com

Manufacturing:

WOLFFKRAN GmbH

Austraße 72

D-74076 Heilbronn

Germany

Phone + 49 7131 9815 0

Fax + 49 7131 9815 355

info@wolffkran.de

WOLFFKRAN Werk Brandenburg GmbH

Frederik-Ipsen-Straße 5

D-15926 Luckau OT Altno

Germany

Phone + 49 35456 674 0

Fax + 49 35456 674 200

info@wolffkran.de