

Slewing tower crane

WOLFF 7532.16 cross

Technical information

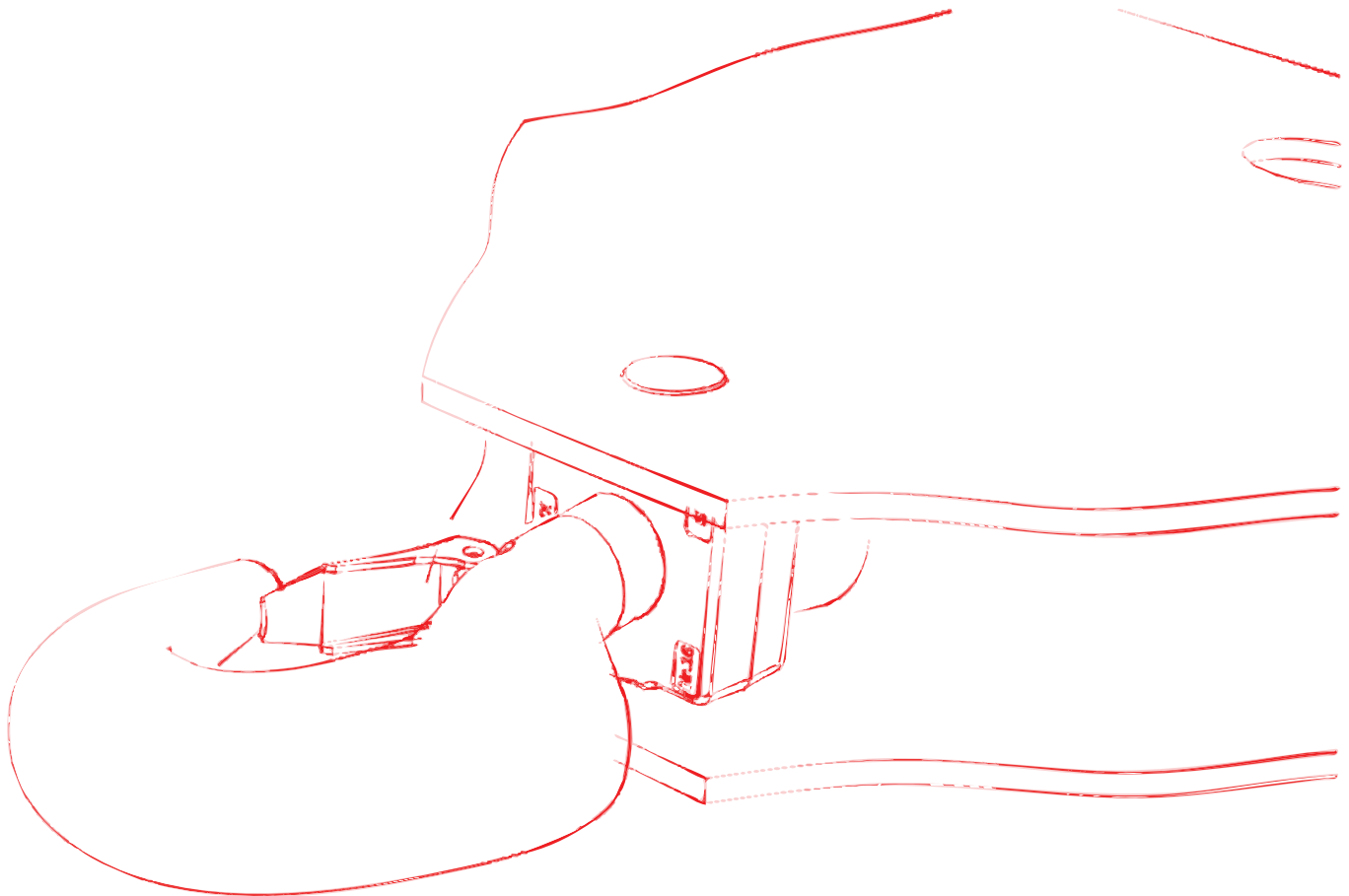

English

English



Published by

WOLFFKRAN GmbH

Austraße 72

74076 Heilbronn

Germany

Phone +49 7131 9815 0

Fax +49 7131 9815 355

www.wolffkran.com

info@wolffkran.de

Copyright

This documentation including all of its subsections is protected by copyright laws.

Any type of use or modification outside of the stringent limits of the copyright laws without permission of WOLFFKRAN GmbH is prohibited and subject to penalties.

This applies particularly for copying, translation, microfilming and storage and processing in electronic systems.

At the time of printing, the information, data, illustrations and notes comprised in this manual were up-to-date.

Subject to change of design, error and typos.

Stand: 03/2017

Table of contents

1	Schedule drawing	5
1.1	Schedule drawing WOLFF 7532.16cross	5
2	Load carrying capacities	6
2.1	Table of load carrying capacity WOLFF 7532.16 (8.3t, 2 fall operation)	7
2.2	Table of load carrying capacities (kg) in meter intervals, WOLFF 7532.16 (8.3 t, 2 fall operation)	8
2.3	Table of load carrying capacity WOLFF 7532.16 (16.5 t, 4 fall operation)	9
2.4	Table of load carrying capacities (kg) in meter intervals, WOLFF 7532.16 (16.5 t, 4 fall operation)	10
3	Tower combinations	11
3.1	Tower combinations on foundation (slewing section with UV20/TV20 - connection)	12
3.2	Tower combinations on cross frame (slewing section with UV20/TV20 - connection)	16
3.3	Tower combinations on cross frame element (slewing section with UV20/TV20 - connection)	21
3.4	Tower combinations on mobile cross frame (slewing section with UV20/TV20 - connection)	22
3.5	Tower combinations on undercarriage (slewing section with UV20/TV20 - connection)	26
4	Foundation loads / central ballast weights / corner loads in compliance with EN 14439 / EN 13001	27
4.1	Foundation loads jib 30 m - 75 m	29
5	Operating speeds	30
6	Package list	32
6.1	Package list 7532.16	32
7	Assembly weights	34
7.1	Counterweight blocks	34
7.1.1	Counterweight block, 2.0 t	35
7.1.2	Counterweight block, 2.7 t	36
7.2	Total weight jib assembly	37
7.3	Assembly weight slewing section	38
7.4	Assembly weight cross frame	39
7.5	Assembly weights traveling cross frame	40

7.6	Assembly weight cross frame elements	42
7.7	Assembly weight undercarriage	43
7.8	Required hook height for mobile cranes	44
8	Assembly diagrams	46
8.1	Jib attachment diagram	46
8.1.1	Trolley jib - attachment diagram 75 m to 60 m	47
8.1.2	Trolley jib - attachment diagram 55 m to 45 m	48
8.1.3	Trolley jib - attachment diagram 40 m to 30 m	49
8.2	Jib brace diagram	50
8.3	Trolley jib mounting rig	52
8.4	Mounting rig for trolley jib	53
8.5	Arrangement of standard railings	54
8.5.1	Standard railings (NG) and accessories	54
8.5.2	Arrangement of standard railings	55
9	Suitable climbing devices	56
9.1	Outer climbing devices	57
9.1.1	Outer climbing device KWH 20.3 / KWH 20.3.1	58
9.1.2	Outer climbing device KWH 20.6 / KWH 20.6.1 / KWH 20.6.2	59
9.2	Inner climbing devices	60
9.2.1	Inner climbing device KSH 20 SH	61
10	Arrangement of counterweight blocks	64

1 Schedule drawing

1.1 Schedule drawing WOLFF 7532.16cross

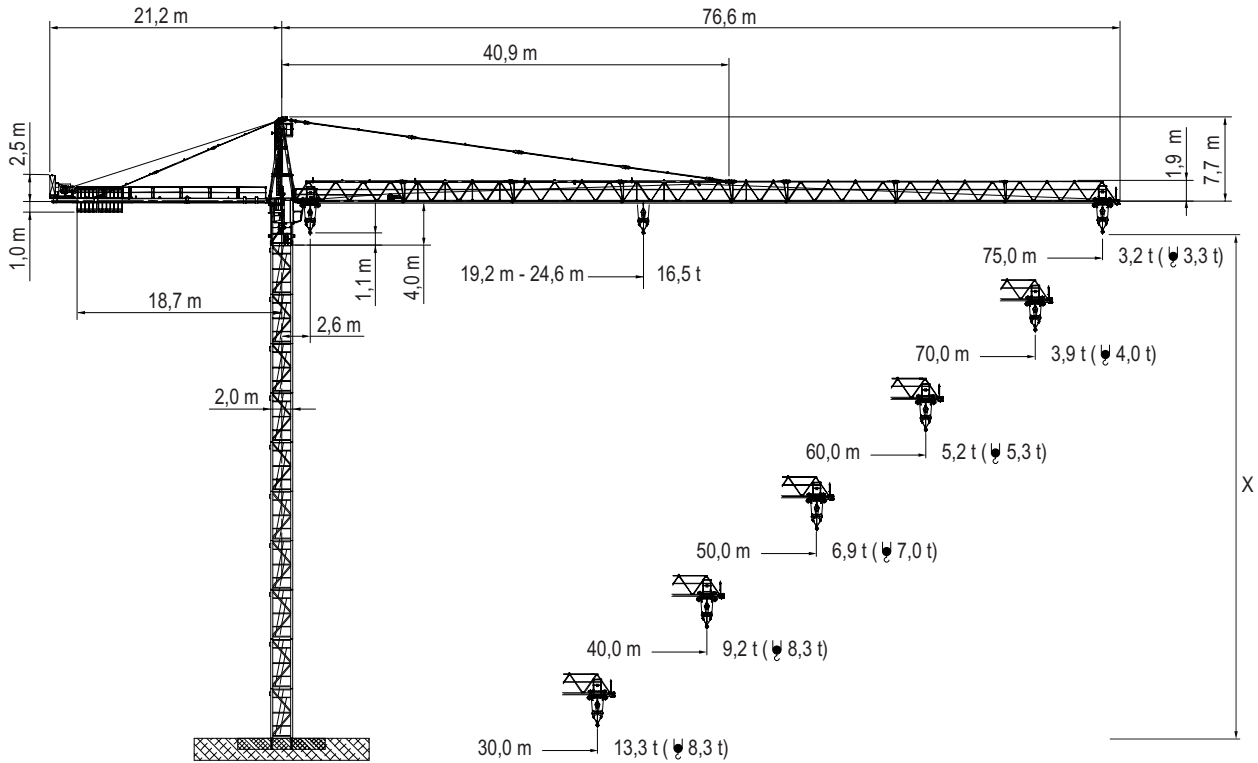

Data WOLFF 7532.16

Item	Data
Crane type	BGL GROUP C.0.10.0315
Design	Overhead travelling crane with top slewing trolley jib, with climbing feature
Type of setup	Stationary or travelling
Basis of calculation	EN 14439 (C25)
Payload torque	max. 4060 kNm
Hoist winch	Hw 875 FU

2 Load carrying capacities

2 Load carrying capacities

	<h3>NOTICE</h3>
<p>WOLFF-Boost</p> <p>With the WOLFF-Boost function, the load is allowed to exceed the load torque range specified for the lifting capacities by up to 10%. This is, however, subject to the restriction that hoisting gear and trolley drive (trolley crane) respectively hoisting gear and derricking gear (luffing crane) must only be moved alternately.</p>	

2.1 Table of load carrying capacity WOLFF 7532.16 (8.3t, 2 fall operation)

 8.3 t		Operating radius [m]	20.0	25.0	30.0	35.0	40.0	45.0	50.0	55.0	60.0	65.0	70.0	75.0	LCC [t]
			JL [m]												
JL [m]	75.0	2.6 – 35.9	8.3	8.3	8.3	8.3	7.3	6.4	5.6	5.0	4.5	4.0	3.6	3.3	
	70.0	2.6 – 38.6	8.3	8.3	8.3	8.3	8.0	6.9	6.1	5.4	4.9	4.4	4.0		
	65.0	2.6 – 40.6	8.3	8.3	8.3	8.3	8.3	7.4	6.5	5.8	5.2	4.7			
	60.0	2.6 – 41.2	8.3	8.3	8.3	8.3	8.3	7.5	6.6	5.9	5.3				
	55.0	2.6 – 42.4	8.3	8.3	8.3	8.3	8.3	7.7	6.8	6.1					
	50.0	2.6 – 43.2	8.3	8.3	8.3	8.3	8.3	7.9	7.0						
	45.0	2.6 – 44.1	8.3	8.3	8.3	8.3	8.3	8.1							
	40.0	2.6 – 40.0	8.3	8.3	8.3	8.3	8.3								
	35.0	2.6 – 35.0	8.3	8.3	8.3	8.3									
	30.0	2.6 – 30.0	8.3	8.3	8.3										

JL	Jib length
LCC	Load carrying capacity

The load carrying capacity is related to a hook range of 42.0 m. Hook ranges greater than that reduce the maximum load carrying capacity by the weight of the additional hoisting ropes (2 fall operation = 2.5 kg per meter of the hook range).

2 Load carrying capacities

2.2 Table of load carrying capacities (kg) in meter intervals, WOLFF 7532.16 (8.3 t, 2 fall operation)

Operating radius [m]	Jib length [m]									
	30.0	35.0	40.0	45.0	50.0	55.0	60.0	65.0	70.0	75.0
10	8300	8300	8300	8300	8300	8300	8300	8300	8300	8300
11	8300	8300	8300	8300	8300	8300	8300	8300	8300	8300
12	8300	8300	8300	8300	8300	8300	8300	8300	8300	8300
13	8300	8300	8300	8300	8300	8300	8300	8300	8300	8300
14	8300	8300	8300	8300	8300	8300	8300	8300	8300	8300
15	8300	8300	8300	8300	8300	8300	8300	8300	8300	8300
16	8300	8300	8300	8300	8300	8300	8300	8300	8300	8300
17	8300	8300	8300	8300	8300	8300	8300	8300	8300	8300
18	8300	8300	8300	8300	8300	8300	8300	8300	8300	8300
19	8300	8300	8300	8300	8300	8300	8300	8300	8300	8300
20	8300	8300	8300	8300	8300	8300	8300	8300	8300	8300
21	8300	8300	8300	8300	8300	8300	8300	8300	8300	8300
22	8300	8300	8300	8300	8300	8300	8300	8300	8300	8300
23	8300	8300	8300	8300	8300	8300	8300	8300	8300	8300
24	8300	8300	8300	8300	8300	8300	8300	8300	8300	8300
25	8300	8300	8300	8300	8300	8300	8300	8300	8300	8300
26	8300	8300	8300	8300	8300	8300	8300	8300	8300	8300
27	8300	8300	8300	8300	8300	8300	8300	8300	8300	8300
28	8300	8300	8300	8300	8300	8300	8300	8300	8300	8300
29	8300	8300	8300	8300	8300	8300	8300	8300	8300	8300
30	8300	8300	8300	8300	8300	8300	8300	8300	8300	8300
31		8300	8300	8300	8300	8300	8300	8300	8300	8300
32		8300	8300	8300	8300	8300	8300	8300	8300	8300
33		8300	8300	8300	8300	8300	8300	8300	8300	8300
34		8300	8300	8300	8300	8300	8300	8300	8300	8300
35		8300	8300	8300	8300	8300	8300	8300	8300	8300
36		8300	8300	8300	8300	8300	8300	8300	8300	8270
37			8300	8300	8300	8300	8300	8300	8300	8010
38			8300	8300	8300	8300	8300	8300	8300	7770
39			8300	8300	8300	8300	8300	8300	8200	7540
40			8300	8300	8300	8300	8300	8300	7970	7320
41				8300	8300	8300	8300	8210	7740	7110
42				8300	8300	8300	8120	7980	7530	6910
43				8300	8300	8160	7910	7760	7320	6720
44				8300	8130	7950	7700	7560	7130	6530
45				8100	7920	7740	7500	7360	6940	6360
46					7720	7550	7310	7170	6760	6190
47					7530	7360	7120	6990	6590	6030
48					7350	7180	6950	6820	6420	5880
49					7170	7000	6780	6660	6270	5740
50					7000	6840	6620	6500	6120	5600
51						6680	6460	6340	5970	5460
52						6530	6310	6200	5830	5330
53						6380	6170	6060	5700	5210
54						6240	6030	5920	5570	5090
55						6100	5900	5790	5440	4970
56							5770	5660	5320	4860
57								5650	5540	5210
58								5530	5420	5090
59								5410	5310	4990
60								5300	5200	4880
61									5090	4780
62									4990	4680
63									4890	4590
64									4790	4500
65								4700	4410	4010
66									4320	3930
67									4240	3850
68									4160	3770
69									4080	3700
70									4000	3630
71										3560
72										3490
73										3430
74										3360
75										3300

2.3 Table of load carrying capacity WOLFF 7532.16 (16.5 t, 4 fall operation)

●● 16.5 t		Operating radius[m]	20.0	25.0	30.0	35.0	40.0	45.0	50.0	55.0	60.0	65.0	70.0	75.0	
JL [m]	75.0	2.6 – 19.2	15.8	12.4	10.1	8.5	7.2	6.3	5.5	4.9	4.4	3.9	3.5	3.2	LCC [t]
	70.0	2.6 – 20.7	16.5	13.4	11.0	9.2	7.9	6.8	6.0	5.3	4.8	4.3	3.9		
	65.0	2.6 – 21.8	16.5	14.2	11.6	9.7	8.3	7.3	6.4	5.7	5.1	4.6			
	60.0	2.6 – 22.1	16.5	14.4	11.8	9.9	8.5	7.4	6.5	5.8	5.2				
	55.0	2.6 – 22.7	16.5	14.9	12.2	10.2	8.8	7.6	6.7	6.0					
	50.0	2.6 – 23.2	16.5	15.2	12.4	10.5	9.0	7.8	6.9						
	45.0	2.6 – 23.6	16.5	15.5	12.7	10.7	9.2	8.0							
	40.0	2.6 – 23.7	16.5	15.6	12.7	10.7	9.2								
	35.0	2.6 – 24.2	16.5	16.0	13.1	11.0									
	30.0	2.6 – 24.6	16.5	16.2	13.3										

JL	Jib length
LCC	Load carrying capacity



The load carrying capacity is related to a hook range of 42.0 m. Hook ranges greater than that reduce the maximum load carrying capacity by the weight of the additional hoisting ropes (4 fall operation = 5.0 kg per meter of the hook range).

2 Load carrying capacities

2.4 Table of load carrying capacities (kg) in meter intervals, WOLFF 7532.16 (16.5 t, 4 fall operation)

Operating radius [m]	Jib length [m]									
	30.0	35.0	40.0	45.0	50.0	55.0	60.0	65.0	70.0	75.0
10	16500	16500	16500	16500	16500	16500	16500	16500	16500	16500
11	16500	16500	16500	16500	16500	16500	16500	16500	16500	16500
12	16500	16500	16500	16500	16500	16500	16500	16500	16500	16500
13	16500	16500	16500	16500	16500	16500	16500	16500	16500	16500
14	16500	16500	16500	16500	16500	16500	16500	16500	16500	16500
15	16500	16500	16500	16500	16500	16500	16500	16500	16500	16500
16	16500	16500	16500	16500	16500	16500	16500	16500	16500	16500
17	16500	16500	16500	16500	16500	16500	16500	16500	16500	16500
18	16500	16500	16500	16500	16500	16500	16500	16500	16500	16500
19	16500	16500	16500	16500	16500	16500	16500	16500	16500	16500
20	16500	16500	16500	16500	16500	16500	16500	16500	16500	15820
21	16500	16500	16500	16500	16500	16500	16500	16500	16240	15000
22	16500	16500	16500	16500	16500	16500	16500	16310	15440	14260
23	16500	16500	16500	16500	16500	16280	15800	15540	14710	13580
24	16500	16500	16260	16220	15880	15550	15090	14830	14040	12950
25	16240	15960	15550	15510	15190	14870	14430	14180	13420	12380
26	15560	15290	14900	14860	14550	14240	13820	13590	12850	11850
27	14930	14670	14300	14260	13960	13660	13250	13030	12320	11360
28	14350	14100	13740	13700	13410	13130	12730	12520	11840	10900
29	13810	13560	13220	13180	12900	12630	12240	12040	11380	10480
30	13300	13070	12730	12700	12430	12160	11790	11590	10950	10090
31		12600	12270	12240	11980	11720	11360	11170	10560	9710
32		12160	11850	11810	11560	11310	10970	10780	10180	9370
33		11750	11450	11410	11170	10930	10590	10410	9830	9040
34		11360	11070	11040	10800	10560	10240	10060	9500	8740
35		11000	10710	10680	10450	10220	9910	9730	9190	8450
36			10380	10350	10120	9900	9590	9430	8900	8170
37			10060	10030	9810	9600	9300	9130	8620	7910
38			9760	9730	9520	9310	9020	8860	8350	7670
39			9470	9440	9240	9030	8750	8590	8100	7440
40			9200	9170	8970	8770	8500	8340	7870	7220
41				8920	8720	8520	8250	8110	7640	7010
42				8670	8480	8290	8020	7880	7430	6810
43				8440	8250	8060	7810	7660	7220	6620
44				8210	8030	7850	7600	7460	7030	6430
45				8000	7820	7640	7400	7260	6840	6260
46					7620	7450	7210	7070	6660	6090
47					7430	7260	7020	6890	6490	5930
48					7250	7080	6850	6720	6320	5780
49					7070	6900	6680	6560	6170	5640
50					6900	6740	6520	6400	6020	5500
51						6580	6360	6240	5870	5360
52						6430	6210	6100	5730	5230
53						6280	6070	5960	5600	5110
54						6140	5930	5820	5470	4990
55						6000	5800	5690	5340	4870
56							5670	5560	5220	4760
57							5550	5440	5110	4650
58							5430	5320	4990	4550
59							5310	5210	4890	4440
60							5200	5100	4780	4350
61								4990	4680	4250
62								4890	4580	4160
63								4790	4490	4070
64								4690	4400	3990
65								4600	4310	3910
66									4220	3830
67									4140	3750
68									4060	3670
69									3980	3600
70									3900	3530
71										3460
72										3390
73										3330
74										3260
75										3200

3 Tower combinations

	<p style="text-align: center;">! DANGER</p> <p>Usage of incorrect tower combinations. The slewing tower crane may overturn.</p> <ol style="list-style-type: none">1) Use the specified tower combinations.2) If you need another tower combination that is not specified here, please contact WOLFFKRAN to get an approved alternative setup in writing.
	<p style="text-align: center;">NOTICE</p> <p>All tower combinations apply to free standing slewing tower cranes without climbing gear.</p>
	<p style="text-align: center;">NOTICE</p> <p>For tower combination with tower element TV 25 and UV 25 please contact WOLFFKRAN.</p>

3 Tower combinations

3.1 Tower combinations on foundation (slewing section with UV20/TV20 - connection)

Jib length	30 m – 75 m				
Item					
1	4.5 m	UV 20.4	TV 20.4	UV 20.4	
2	9.0 m	UV 20.4	TV 20.4	UV 20.4	
3	13.5 m	UV 20.4	TV 20.4	UV 20.4	
4	18.0 m	UV 20.4	TV 20.4	UV 20.4	
5	22.5 m	UV 20.4	TV 20.4	UV 20.4	
6	27.0 m	UV 20.4	TV 20.4	TVA 20.4	
7	31.5 m	UV 20.4	TV 20.4	TV 20.4	
8	36.0 m		TV 20.4	TV 20.4	
9	40.5 m		TV 20.4	TV 20.4	
10	45.0 m		TV 20.4	TV 20.4	
11	49.5 m		TV 20.4	TV 20.4	
12	54.0 m		TV 20.4	TV 20.4	
13	58.5 m		TV 20.4	TV 20.4	
14	63.0 m			TV 20.4	
Foundation anchors		FUA 120 Type C-120	FUA 140 Type D-140	FUA 140 Type D-140	
Tower height [m]		31.5	58.5	63.0	
Hook height double reeving [m]		33.0	60.0	64.5	
Hook height 4 fall operation [m]		32.6	59.6	64.1	
Wind category		C25			

Jib length	30 m – 75 m			
Item				
1	4.5 m	UV 20.4		
2	9.0 m	UV 20.4		
3	13.5 m	UV 20.4		
4	18.0 m	UV 20.4		
5	22.5 m	TVA 20.4		
6	27.0 m	TV 20.4		
7	31.5 m	TV 20.4		
8	36.0 m	TV 20.4		
9	40.5 m	TV 20.4		
10	45.0 m	TV 20.4		
11	49.5 m	TV 20.4		
12	54.0 m	TV 20.4		
13	55.0 m	VR 2023		
14	59.5 m	TV 23		
15	64.0 m	HTA 23		
16	68.5 m	HT 23		
17	73.0 m	HT 23		
18	77.5 m	HT 23		
Foundation anchors		FUA G 160		
Tower height [m]		77.5		
Hook height double reeving [m]		79.0		
Hook height 4 fall operation [m]		78.6		
Wind category	C25			

3 Tower combinations

Jib length	30 m – 75 m			
Item				
1	4.5 m	UV 20.4		
2	9.0 m	UV 20.4		
3	13.5 m	UV 20.4		
4	18.0 m	UV 20.4		
5	22.5 m	TVA 20.4		
6	27.0 m	TV 20.4		
7	31.5 m	TV 20.4		
8	36.0 m	TV 20.4		
9	40.5 m	TV 20.4		
10	45.0 m	TV 20.4		
11	49.5 m	TV 20.4		
12	54.0 m	TV 20.4		
13	55.0 m	VR 2023		
14	59.5 m	TV 23		
15	64.0 m	HTA 23		
16	68.5 m	HT 23		
17	73.0 m	HT 23		
18	84.3 m	BT 23		
Foundation anchors		FUA 210 G		
Tower height [m]		84.3		
Hook height double reeving [m]		85.8		
Hook height 4 fall operation [m]		85.4		
Wind category		C25		

Jib length	30 m – 75 m			
Item				
1	4.5 m	UV 20.4		
2	9.0 m	UV 20.4		
3	13.5 m	UV 20.4		
4	18.0 m	UV 20.4		
5	22.5 m	TVA 20.4		
6	27.0 m	TV 20.4		
7	31.5 m	TV 20.4		
8	36.0 m	TV 20.4		
9	40.5 m	TV 20.4		
10	45.0 m	TV 20.4		
11	49.5 m	TV 20.4		
12	54.0 m	TV 20.4		
13	55.0 m	VR 2023		
14	59.5 m	TV 23		
15	64.0 m	HTA 23		
16	68.5 m	HT 23		
17	73.0 m	HT 23		
18	74.2 m	VR 23/25-29		
19	78.7 m	UV 29		
20	88.7 m	BT 29		
Foundation anchors		FUA BT 29		
Tower height [m]		88.7		
Hook height double reeving [m]		90.2		
Hook height 4 fall operation [m]		89.8		
Wind category	C25			

3 Tower combinations

3.2 Tower combinations on cross frame (slewing section with UV20/TV20 - connection)

Jib length	30 m – 75 m				
Item					
1	4.5 m	UV 20.4	UV 20.4	UV 20.4	UV 20.4
2	9.0 m	UV 20.4	UV 20.4	UV 20.4	UV 20.4
3	13.5 m	UV 20.4	UV 20.4	UV 20.4	UV 20.4
4	18.0 m	UV 20.4	UV 20.4	UV 20.4	UV 20.4
5	22.5 m	UV 20.4	UV 20.4	UV 20.4	UV 20.4
6	27.0 m	TVA 20.4	UV 20.4	TVA 20.4	TVA 20.4
7	31.5 m	TV 20.4	TVA 20.4	TV 20.4	TV 20.4
8	36.0 m	TV 20.4	TV 20.4	TV 20.4	TV 20.4
9	40.5 m	TV 20.4		TV 20.4	TV 20.4
10	45.0 m	TV 20.4		TV 20.4	TV 20.4
11	49.5 m			TV 20.4	TV 20.4
12	54.0 m			TV 20.4	TV 20.4
13	58.5 m			TV 20.4	TV 20.4
14	63.0 m			TV 20.4	
Substructure		KR 10-46	KR 10-46/60	KRV 10-60	KRV 10-60
Corner distance [m x m]		4.6 x 4.6	6.0 x 6.0	5.0 x 5.0	6.0 x 6.0
Substructure height [m]		1.2	1.2	1.2	1.2
Tower height [m]		46.2	37.2	64.2	59.7
Hook height double reeving [m]		47.7	38.7	65.7	61.2
Hook height 4 fall operation [m]		47.3	38.3	65.3	60.8
Wind category		C25			

Jib length	30 m – 75 m			
Item				
1	4.5 m	UV 20.4		
2	9.0 m	UV 20.4		
3	13.5 m	UV 20.4		
4	18.0 m	UV 20.4		
5	22.5 m	TVA 20.4		
6	27.0 m	TV 20.4		
7	31.5 m	TV 20.4		
8	36.0 m	TV 20.4		
9	40.5 m	TV 20.4		
10	45.0 m	TV 20.4		
11	49.5 m	TV 20.4		
12	54.0 m	TV 20.4		
13	55.0 m	VR 2023		
14	59.5 m	TV 23		
15	64.0 m	TV 23		
Substructure		KRV 10-60		
Corner distance [m x m]		5.0 x 5.0 6.0 x 6.0		
Substructure height [m]		1.2		
Tower height [m]		65.2		
Hook height double reeving [m]		66.7		
Hook height 4 fall operation [m]		66.3		
Wind category		C25		

3 Tower combinations

Jib length	30 m – 75 m			
Item				
1	4.5 m	UV 20.4	UV 20.4	
2	9.0 m	UV 20.4	UV 20.4	
3	13.5 m	UV 20.4	UV 20.4	
4	18.0 m	UV 20.4	UV 20.4	
5	22.5 m	UV 20.4	UV 20.4	
6	27.0 m	TVA 20.4	TVA 20.4	
7	31.5 m	TV 20.4	TV 20.4	
8	36.0 m	TV 20.4	TV 20.4	
9	40.5 m	TV 20.4	TV 20.4	
10	45.0 m	TV 20.4	TV 20.4	
11	49.5 m	TV 20.4	TV 20.4	
12	54.0 m	TV 20.4	TV 20.4	
13	58.5 m	TVÜ 20.4	TV 20.4	
14	63.0 m		TV 20.4	
Substructure		KR 1000-8	KR 12-60 KR 12-60/80	
Corner distance [m x m]		8.0 x 8.0	6.0 x 6.0 8.0 x 8.0	
Substructure height [m]		1.2	1.4	
Tower height [m]		59.7	64.4	
Hook height double reeving [m]		61.2	65.9	
Hook height 4 fall operation [m]		60.8	65.5	
Wind category		C25		

Jib length	30 m – 75 m			
Item				
1	4.5 m	UV 20.4	UV 20.4	
2	9.0 m	UV 20.4	UV 20.4	
3	13.5 m	UV 20.4	UV 20.4	
4	18.0 m	UV 20.4	UV 20.4	
5	22.5 m	TVA 20.4	TVA 20.4	
6	27.0 m	TV 20.4	TV 20.4	
7	31.5 m	TV 20.4	TV 20.4	
8	36.0 m	TV 20.4	TV 20.4	
9	40.5 m	TV 20.4	TV 20.4	
10	45.0 m	TV 20.4	TV 20.4	
11	49.5 m	TV 20.4	TV 20.4	
12	54.0 m	TV 20.4	TV 20.4	
13	55.0 m	VR 2023	VR 2023	
14	59.5 m	TV 23	TV 23	
15	64.0 m	TV 23	HTA 23	
16	68.5 m	HTA 23	HT 23	
17	73.0 m	HT 23	HT 23	
18	77.5 m		HT 23	
Substructure		KR 12-60 KR 12-60/80	KR 16-80 KR 16-80/100	
Corner distance [m x m]		6.0 x 6.0 8.0 x 8.0	8.0 x 8.0 10.0 x 10.0	
Substructure height [m]		1.4	1.8	
Tower height [m]		74.4	79.3	
Hook height double reeving [m]		75.9	80.8	
Hook height 4 fall operation [m]		75.5	80.4	
Wind category		C25		

3 Tower combinations

Jib length	30 m – 75 m			
Item				
1	4.5 m	UV 20.4		
2	9.0 m	UV 20.4		
3	13.5 m	UV 20.4		
4	18.0 m	UV 20.4		
5	22.5 m	TVA 20.4		
6	27.0 m	TV 20.4		
7	31.5 m	TV 20.4		
8	36.0 m	TV 20.4		
9	40.5 m	TV 20.4		
10	45.0 m	TV 20.4		
11	49.5 m	TV 20.4		
12	54.0 m	TV 20.4		
13	55.0 m	VR 2023		
14	59.5 m	TV 23		
15	64.0 m	HTA 23		
16	68.5 m	HT 23		
17	73.0 m	HT 23		
18	74.2 m	VR 23/25-29		
19	78.7 m	UV 29		
20	88.7 m	BT 29		
Substructure		KR 16-80 KR 16-80/100		
Corner distance [m x m]		8.0 x 8.0 10.0 x 10.0		
Substructure height [m]		1.8		
Tower height [m]		90.5		
Hook height double reeving [m]		92.0		
Hook height 4 fall operation [m]		91.6		
Wind category			C25	

3.3 Tower combinations on cross frame element (slewing section with UV20/TV20 - connection)

Jib length	30 m – 75 m			
Item				
1	4.5 m	UV 20.4	UV 20.4	
2	9.0 m	UV 20.4	UV 20.4	
3	13.5 m	UV 20.4	UV 20.4	
4	18.0 m	UV 20.4	UV 20.4	
5	22.5 m	UV 20.4	UV 20.4	
6	27.0 m	TVA 20.4	TVA 20.4	
7	31.5 m	TV 20.4	TV 20.4	
8	36.0 m	TV 20.4	TV 20.4	
9	40.5 m	TV 20.4	TV 20.4	
10	45.0 m		TV 20.4	
11	49.5 m		TV 20.4	
12	54.0 m		TV 20.4	
13	58.5 m		TVÜ 20.4	
14	63.0 m		UVA 25	
Substructure		KRE 260.2	KRE 480	
Corner distance [m x m]		6.0 x 6.0	8.0 x 8.0	
Substructure height [m]		4.0	4.0	
Tower height [m]		44.5	67.0	
Hook height double reeving [m]		46.0	68.5	
Hook height 4 fall operation [m]		45.6	68.1	
Wind category		C25		

3 Tower combinations

3.4 Tower combinations on mobile cross frame (slewing section with UV20/TV20 - connection)

Jib length	30 m – 75 m				
Item					
1	4.5 m	UV 20.4	UV 20.4	UV 20.4	
2	9.0 m	UV 20.4	UV 20.4	UV 20.4	
3	13.5 m	UV 20.4	UV 20.4	UV 20.4	
4	18.0 m	UV 20.4	UV 20.4	UV 20.4	
5	22.5 m	TVA 20.4	TVA 20.4	TVA 20.4	
6	27.0 m	TV 20.4	TV 20.4	TV 20.4	
7	31.5 m	TV 20.4	TV 20.4	TV 20.4	
8	36.0 m	TV 20.4	TV 20.4	TV 20.4	
9	40.5 m	TV 20.4	TV 20.4	TV 20.4	
10	45.0 m	TV 20.4	TV 20.4	TV 20.4	
11	49.5 m	TV 20.4	TV 20.4	TV 20.4	
12	54.0 m		TV 20.4	TV 20.4	
13	58.5 m		TV 20.4	TV 20.4	
Substructure		KRF 10-46/60	KRF4 12-60/80	KRF6 12-60/80	
Corner distance [m x m]		6.0 x 6.0	8.0 x 8.0	8.0 x 8.0	
Substructure height [m]		2.0	2.5	2.9	
Tower height [m]		51.5	61.0	61.4	
Hook height double reeving [m]		53.0	62.5	62.9	
Hook height 4 fall operation [m]		52.6	62.1	62.5	
Wind category		C25			

Jib length	30 m – 75 m			
Item				
1	4.5 m	UV 20.4		
2	9.0 m	UV 20.4		
3	13.5 m	UV 20.4		
4	18.0 m	UV 20.4		
5	22.5 m	TVA 20.4		
6	27.0 m	TV 20.4		
7	31.5 m	TV 20.4		
8	36.0 m	TV 20.4		
9	40.5 m	TV 20.4		
10	45.0 m	TV 20.4		
11	49.5 m	TV 20.4		
12	50.5 m	VR 2023		
13	55.0 m	TV 23		
14	59.5 m	TV 23		
15	64.0 m	HTA 23		
16	68.5 m	HT 23		
Substructure		KRF6 12-60/80		
Corner distance [m x m]		8.0 x 8.0		
Substructure height [m]		2.9		
Tower height [m]		71.4		
Hook height double reeving [m]		72.9		
Hook height 4 fall operation [m]		72.5		
Wind category			C25	

3 Tower combinations



Jib length	30 m – 75 m			
Item				
1	4.5 m	UV 20.4		
2	9.0 m	UV 20.4		
3	13.5 m	UV 20.4		
4	18.0 m	TVA 20.4		
5	22.5 m	TV 20.4		
6	27.0 m	TV 20.4		
7	31.5 m	TV 20.4		
8	36.0 m	TV 20.4		
9	40.5 m	TV 20.4		
10	45.0 m	TV 20.4		
11	46.0 m	VR 2023		
12	50.5 m	TV 23		
13	55.0 m	TV 23		
14	59.5 m	TV 23		
15	64.0 m	HTA 23		
16	68.5 m	HT 23		
17	73.0 m	HT 23		
18	77.5 m	HT 23		
Substructure		KRF 16-80/100		
Corner distance [m x m]		10.0 x 10.0		
Substructure height [m]		3.3		
Tower height [m]		80.8		
Hook height double reeving [m]		82.3		
Hook height 4 fall operation [m]		81.9		
Wind category			C25	

3 Tower combinations

3.5 Tower combinations on undercarriage (slewing section with UV20/TV20 - connection)

Jib length		30 m – 75 m			
Item					
1	4.5 m	UV 20.4	UV 20.4		
2	9.0 m	UV 20.4	UV 20.4		
3	13.5 m	UV 20.4	UV 20.4		
4	18.0 m	UV 20.4	UV 20.4		
5	22.5 m	TVA 20.4	TVA 20.4		
6	27.0 m	TV 20.4	TV 20.4		
7	31.5 m	TV 20.4	TV 20.4		
8	36.0 m	TV 20.4	TV 20.4		
9	40.5 m	TV 20.4	TV 20.4		
10	45.0 m		TV 20.4		
11	49.5 m		TV 20.4		
12	54.0 m		TVÜ 20.4		
13	58.5 m		UVA 25		
Substructure		UW 260.3	UW 480		
Corner distance [m x m]		6.0 x 6.0	8.0 x 8.0		
Substructure height [m]		4.5	5.0		
Tower height [m]		45.0	63.5		
Hook height double reeving [m]		46.5	65.0		
Hook height 4 fall operation [m]		46.1	64.6		
Wind category		C25			

4 Foundation loads / central ballast weights / corner loads in compliance with EN 14439 / EN 13001

	<div style="background-color: red; color: white; text-align: center; padding: 5px;">! DANGER</div> <p>Usage of incorrect tower combinations. The slewing tower crane may overturn.</p> <ol style="list-style-type: none"> 1) Use the specified tower combinations. 2) If you need another tower combination that is not specified here, please contact WOLFFKRAN to get an approved alternative setup in writing.
	<div style="background-color: #00a0e3; color: white; text-align: center; padding: 5px;">NOTICE</div> <p>If you need foundation loads for tower combination with tower element TV 25 and UV 25, please contact WOLFFKRAN to get an approved alternative setup.</p>

Jib positions

The corner loads are given for two jib positions with the maximum corner load resulting from jib position 1.

For square setup, the following equation is true: $a = b$

For rectangular setup, the following equation is true: $a > b$

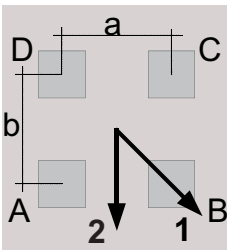

Cross frame or cross frame element

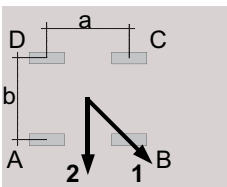

Undercarriage

NOTICE! For undercarriage details, please refer to the relevant operating manual.

Wind load with crane out of service

The stability for stormy weather is calculated on the basis of wind region C (EN 13001-2). The reference wind speed for zone C is 28 m/s (10 m above ground, averaged over 10 minutes). As a basis, a recurrence interval of 25 years is used. As a basis, a recurrence interval of 25 years is used.

4 Foundation loads / central ballast weights / corner loads in compliance with EN 14439 / EN 13001

Please contact WOLFFKRAN for stability calculations in other wind regions.

For information on the different substructures, refer to Section 5 of the Operating Manual.

4.1 Foundation loads jib 30 m - 75 m

Slewing section 7532 cross with 30 m – 75 m jib on foundation.
Slewing tower crane without climbing device.

Foundation load in compliance with EN 14439 / EN 13001 – typical loads

Includes all dynamical factors under consideration of second-order theory for stationary slewing tower cranes on concrete foundation in compliance with a tower combination without climbing device.

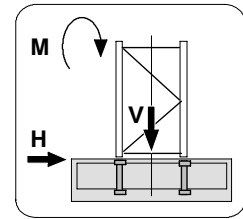

HH		Crane in service			Crane out of service			Assembly		
4	2	Slewing torque: 390 kNm			Wind category C25			M	V	H
STR	STR	M	V	H	M	V	H	M	V	H
[m]	[m]	[kNm]	[kN]	[kN]	[kNm]	[kN]	[kN]	[kNm]	[kN]	[kN]
5.6	6.0	2810	642	25	2100	545	41	3370	455	8
10.1	10.5	2930	661	26	2290	573	47	3420	473	9
14.6	15.0	3070	679	28	2520	601	53	3470	492	9
19.1	19.5	3220	697	29	2790	629	59	3540	510	10
23.6	24.0	3400	715	31	3080	658	65	3620	528	11
28.1	28.5	3590	733	32	3420	686	71	3710	546	12
32.6	33.0	3800	752	34	3790	714	78	3810	564	13
37.1	37.5	3970	800	36	4200	743	84	3880	613	14
41.6	42.0	4200	828	38	4650	771	90	3990	641	16
46.1	46.5	4540	988	43	5140	799	96	4110	669	17
50.6	51.0	4850	1016	45	5680	827	102	4250	698	18
55.1	55.5	5190	1044	47	6420	1049	153	4400	726	19
59.6	60.0	5570	1073	49	7500	1077	164	4580	754	20
64.1	64.5	5870	1051	49	8100	1055	165	4770	783	21
65.1	65.5	5820	1104	51	8280	1109	172	4730	837	22
69.6	70.0	6180	1144	53	9450	1148	184	4900	876	23
74.1	74.5	6570	1183	55	10730	1187	195	5080	915	25
78.6	79.0	7180	1368	58	12150	1227	207	5280	955	26
80.9	81.3	7340	1404	59	12780	1262	215	5350	990	27
85.4	85.8	7870	1443	61	14370	1301	227	5570	1029	28
Tower combination with base tower element BT 29										
89.8	90.2	8150	1502	64	15710	1361	242	5710	1089	29

Caption:

HH:	Hook height	V:	Vertical load	STR:	Number of falls
H:	Horizontal load	M:	Torque		

5 Operating speeds

5 Operating speeds

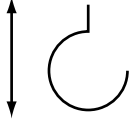
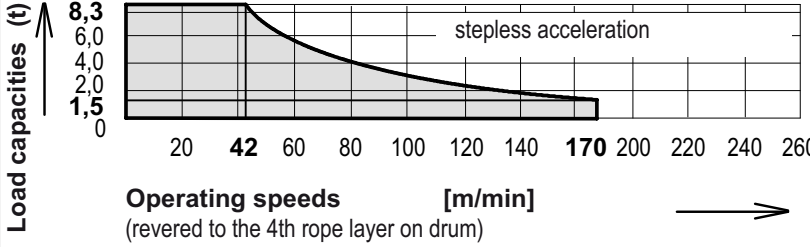
Drive unit [type]	Operating speed Carrying load		Hook travel distance max. [m]	Power [kW]	Total connected wattage [kVA]
Hw875FU	Lifting / lowering		460	75	96.0 Total connected load at coincidence factor of 0.8
	 <p>Load capacities (t)</p> <p>Operating speeds [m/min] (reverted to the 4th rope layer on drum)</p>				

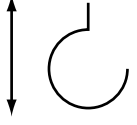
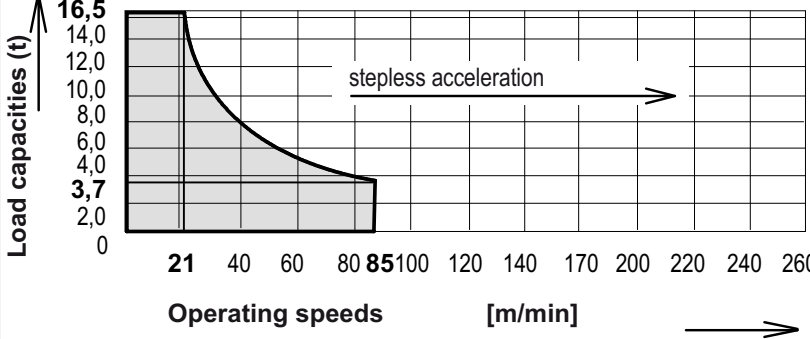
Drive unit [type]	Operating speed Carrying load		Hook travel distance max. [m]	Power [kW]	Total connected wattage [kVA]
Hw875FU	Lifting / lowering		230	75	96.0 Total connected load at coincidence factor of 0.8
	 <p>Load capacities (t)</p> <p>Operating speeds [m/min]</p>				

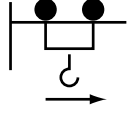
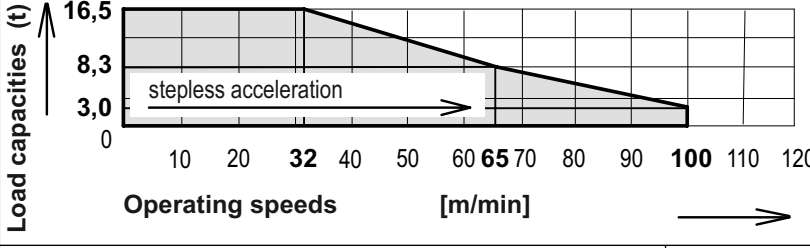

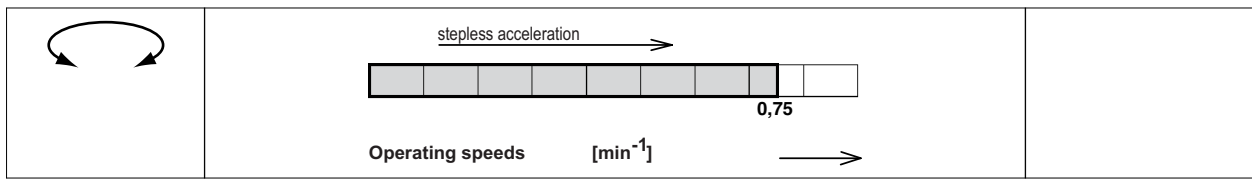

KW	Trolley movement		9.0
	 <p>Load capacities (t)</p> <p>Operating speeds [m/min]</p>		
SG	Slewing		2x6.0





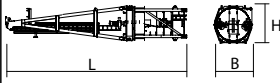
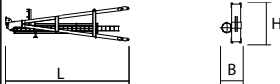
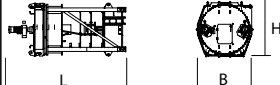
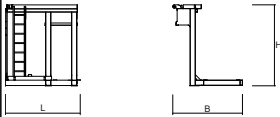
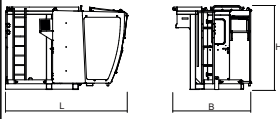
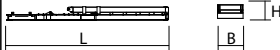

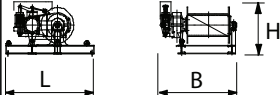
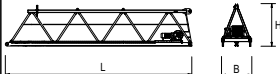
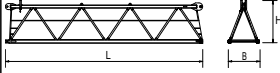
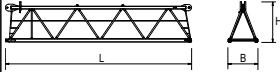
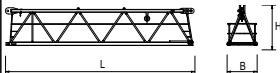

6 Package list

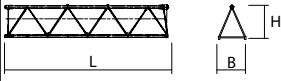
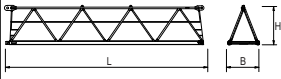
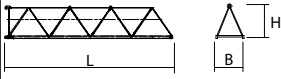
6 Package list

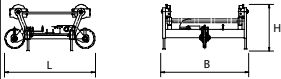
6.1 Package list 7532.16

Quantity	Description	Package	L [m]	W [m]	H [m]	Weight [kg]	Volume [m ³]
1	Tower head section, complete including platforms and misc. stay parts		11.72	2.42	2.42	11250	68.64
	Tower head section upper part including platforms and misc. stay parts		7.45	1.37	2.42	2730	24.70
	Tower head section lower part including slewing frame, ball slew bearing, slewing gears and slip ring system		5.39	2.42	2.42	8520	31.57
1	Driver's cab suspension		2.14	1.95	2.42	680	10.10
1	Driver's cab with driver's cab suspension		3.57	2.29	2.42	1700	19.78
1	Counterjib in hinged position (stay parts)		12.40	2.49	1.05	5500 (555)	32.29
	Counterjib (stay parts)		20.35	2.49	0.65	5500 (555)	32.80
1	Machine platform Hw875FU including hoisting rope (Ø 16 mm x 285 m)		2.48	2.46	2.18	4670	13.30
1	Jib element 1 with traverse gear		10.18	1.64	2.30	3000	38.40
1	Jib element 2		10.21	1.64	2.05	2150	34.32
1	Jib element 3		10.21	1.64	2.03	2000	33.99
1	Jib element 4 (stay parts)		10.27	1.64	2.05	1900 (2820)	34.53
1	Jib element 5		5.26	1.64	2.02	990	17.43

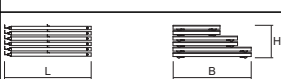
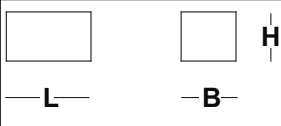
Quantity	Description	Package	L [m]	W [m]	H [m]	Weight [kg]	Volume [m³]
1	Jib element 6		10.24	1.64	2.01	1700	33.76
1	Jib element 7		10.22	1.64	2.00	1260	33.52
1	Jib element 8		10.20	1.64	2.00	1010	33.46
1	Rope swivel cross-beam		1.05	1.54	0.47	135	0.76
1	Trolley LK 8/16		1.87	1.85	1.00	460	3.46
	Maintenance cage		0.75	0.58	1.69	55	0.74
1	Hook block U 8/16		1.02	0.26	1.70	640	0.45
1	Brace rods for 75 m operating radius		10.17	0.92	0.37	2720	3.46
	Standard railings		2.60	1.10	0.65	300	1.86
1	Box (small parts)		0.63	0.50	0.38	100	1.12

7 Assembly weights

7 Assembly weights

7.1 Counterweight blocks

	NOTICE
	<p>The described diagrams of the concrete counterweights and central ballast blocks only show sketches. Have them issue the reinforcement charts by experts.</p>

7.1.1 Counterweight block, 2.0 t

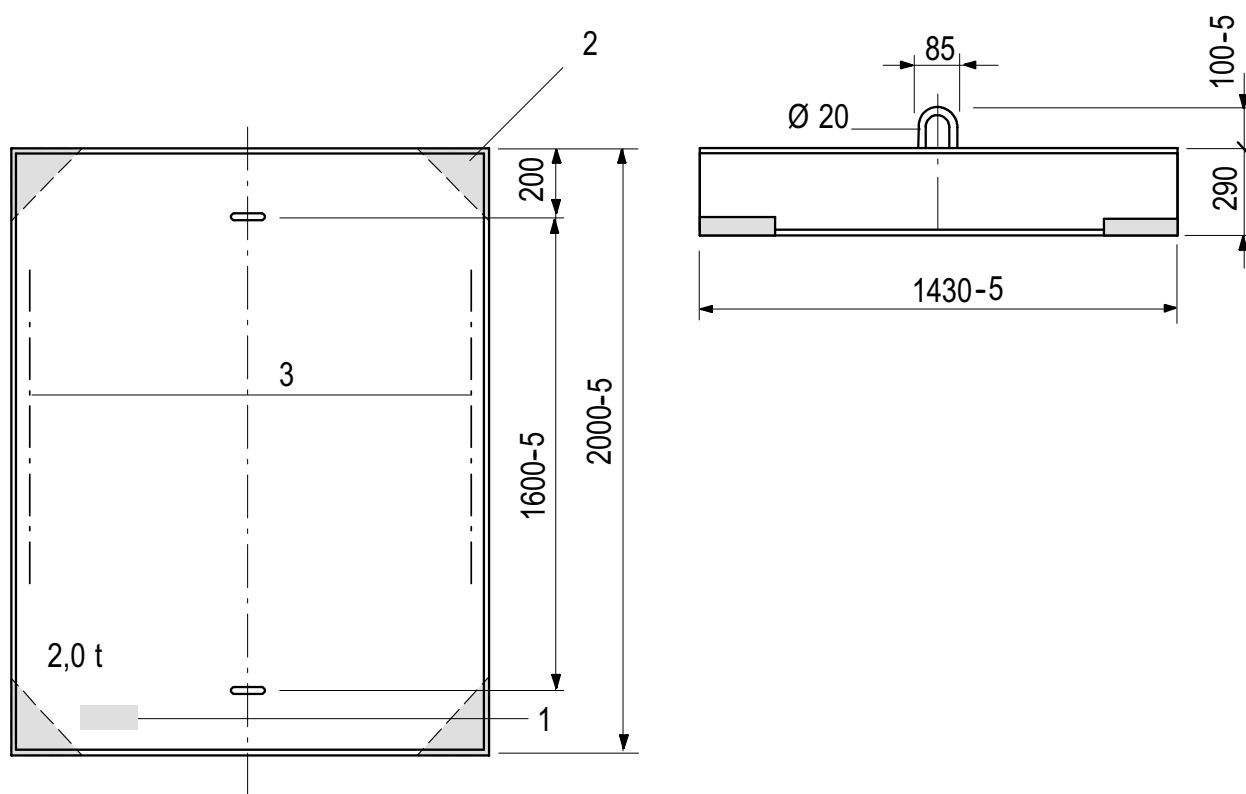

Data counterweight block 2.0 t

Item	Data
Material	Concrete, min. C 20/25
Max. permitted weight tolerance	+/- 3 %
Order number	962-2-006590
1	Component identifier
2	Corner guard
3	Structural steel reinforcement

7 Assembly weights

7.1.2 Counterweight block, 2.7 t

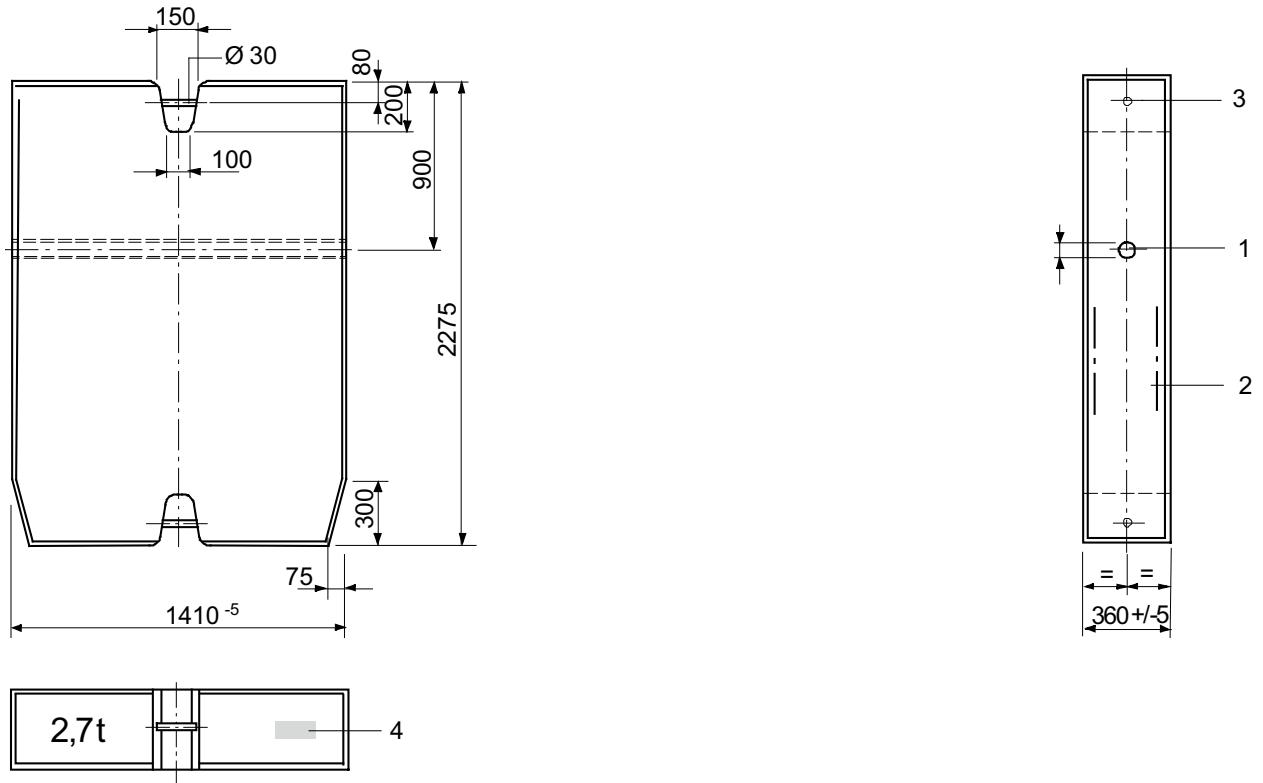

Data counterweight block 2.7 t

Item	Data
Material	Concrete, min. C 20/25
Max. permitted weight tolerance	+/- 3 %
Order number	30021887
1	Connection for stub shaft (Ø 40x 215 Item no.: 30024871)
2	Structural steel reinforcement
3	Suspension
4	Component identifier

7.2 Total weight jib assembly

Assembly weights 7532

Trolley jib, complete: Brace plates, crab, trolley drive rope, snatch block and standard railings

Jib length [m]	Weight [kg] WOLFF 7532
75.0	17700
70.0	16800
65.0	16700
60.0	15800
55.0	14200
50.0	13200
45.0	12900
40.0	12000
35.0	11300
30.0	10300

7 Assembly weights

7.3 Assembly weight slewing section

Module	Crane parts	Weight [kg]	
Tower head section complete (including brace plates, driver's cab, driver's cab suspension, platform and standard railings)			12480
	▪ Tower head section upper part complete	2730	
	▪ Driver's cab with driver's cab suspension	1700	
	▪ Tower head section lower part including slewing frame, ball race bearing, slewing gears, standard railings and slip ring system	8520	
Counterjib with Hw875FU			12450
	▪ Counterjib with 4 brace plates and standard railings	5780	
	▪ Machine platform Hw875FU including hoisting rope (Ø16mm x 285m)	4670	
	▪ Counterweight 2t (below machine platform)	2000	

7.4 Assembly weight cross frame

Module	Crane part	Weight [kg]	
Cross frame KR 10-46 (without accessories)			7000
	▪ 4 bolted spigots UV20	560	
	▪ 4 bolted spigots TV 20	684	
Cross frame KR 10-60 (without accessories)			8200
	▪ 4 bolted spigots UV20	560	
	▪ 4 bolted spigots TV 20	684	
Cross frame KR 1000-8 (without accessories)			14050
	▪ 4 bolted spigots TV 25	684	
	▪ 4 bolted spigots UV25	748	
Mobile cross frame KRF 10-46/60 (without accessories)			17500
	▪ 4 bolted spigots TV 25	684	
	▪ 4 bolted spigots UV25	748	

7 Assembly weights

7.5 Assembly weights traveling cross frame

Module	Crane parts	Weight [kg]	
Mobile cross frame KRF 10 – 46/60 complete			17500
(6.0 m x 6.0 m)	▪ Cross frame	7000	
	▪ Drive gear corners	2385	
	▪ Backing braces	1510	
	▪ Subframe	5645	
	▪ Platforms + ladders	510	
	▪ Control cabinet	130	
	▪ small items	320	
	▪ Set of bolted spigots AZR 120 E 15,5 KRF 10-46/60	605	
	▪ Set of bolted spigots AZR 140 M KRF 10-46/60	760	
Traveling cross frame KRF4 12-60/80 complete			32300
(8.0 m x 8.0 m)	▪ Cross frame	14170	
	▪ Backing braces	2875	
	▪ Drive gear corners	4560	
	▪ Subframe	9380	
	▪ Platforms and ladders	255	
	▪ Control cabinet	130	
	▪ small items	930	
	▪ Set of bolted spigots AZR 140 M KR 12-60/80	790	
	▪ Set of bolted spigots AZ 120 E 15,5 KR 12-60/80	730	
	▪ Set of bolted spigots AZ 140 E 15,5 KR 12-60/80	875	
	▪ Set of bolted spigots AZR 160 M KR 12-60/80	905	
	▪ Set of bolted spigots AZ 140 E 10 KR 12-60/80	790	
	▪ Set of bolted spigots AZR 156 M KR 12-60/80	845	
Traveling cross frame KRF6 12-60/80 complete			41200
(8.0 m x 8.0 m)	▪ Cross frame	14170	
	▪ Backing braces	2875	
	▪ Drive gear corners	4560	
	▪ Subframe	18270	
	▪ Platforms and ladders	255	
	▪ Control cabinet	130	
	▪ small items	940	
	▪ Set of bolted spigots AZR 140 M KR 12-60/80	790	

Module	Crane parts	Weight [kg]
	▪ Set of bolted spigots AZ 120 E 15,5 KR 12-60/80	730
	▪ Set of bolted spigots AZ 140 E 15,5 KR 12-60/80	875
	▪ Set of bolted spigots AZR 160 M KR 12-60/80	905
	▪ Set of bolted spigots AZ 140 E 10 KR 12-60/80	790
	▪ Set of bolted spigots AZR 156 M KR 12-60/80	845

7 Assembly weights

7.6 Assembly weight cross frame elements

Module	Crane parts	Weight [kg]	
	Cross frame element KRE 260.2, complete		10900
	▪ Cross frame platform with hinged section, corner plates and transport locks	5455	
	▪ Mast base with diagonal struts and tie rods	5445	
	Cross frame element KRE 480 complete		24250
	▪ Mast base	7100	
	▪ Hinged sections with corner plates	6250	
	▪ Diagonal struts and ballast carrier	9260	
	▪ Assembly platform, ladder, and small parts	1640	

7.7 Assembly weight undercarriage

Module	Crane parts	Weight [kg]	
Undercarriage UW 260.3, complete			17100
	▪ Undercarriage platform with hinged sections, subframes and transport locks	11220	
	▪ Mast base with diagonal struts and tie rods	5880	
Undercarriage UW 480, complete			34000
	▪ Mast base including control cabinet	7100	
	▪ Hinged sections with mounting device and subframes	16000	
	▪ Diagonal struts and ballast carrier	9260	
	▪ Assembly platform, ladder, and small parts	1640	

7 Assembly weights

7.8 Required hook height for mobile cranes

For information about the height of the WOLFF slewing tower crane, refer to Tower combinations [11].

NOTICE! During assembly, allowances must be made for level differences (mobile crane to base of the slewing tower crane).

Hook height above ground required for mobile cranes (X) = height of the WOLFF slewing tower crane (A) + clearance of 15 m (B).

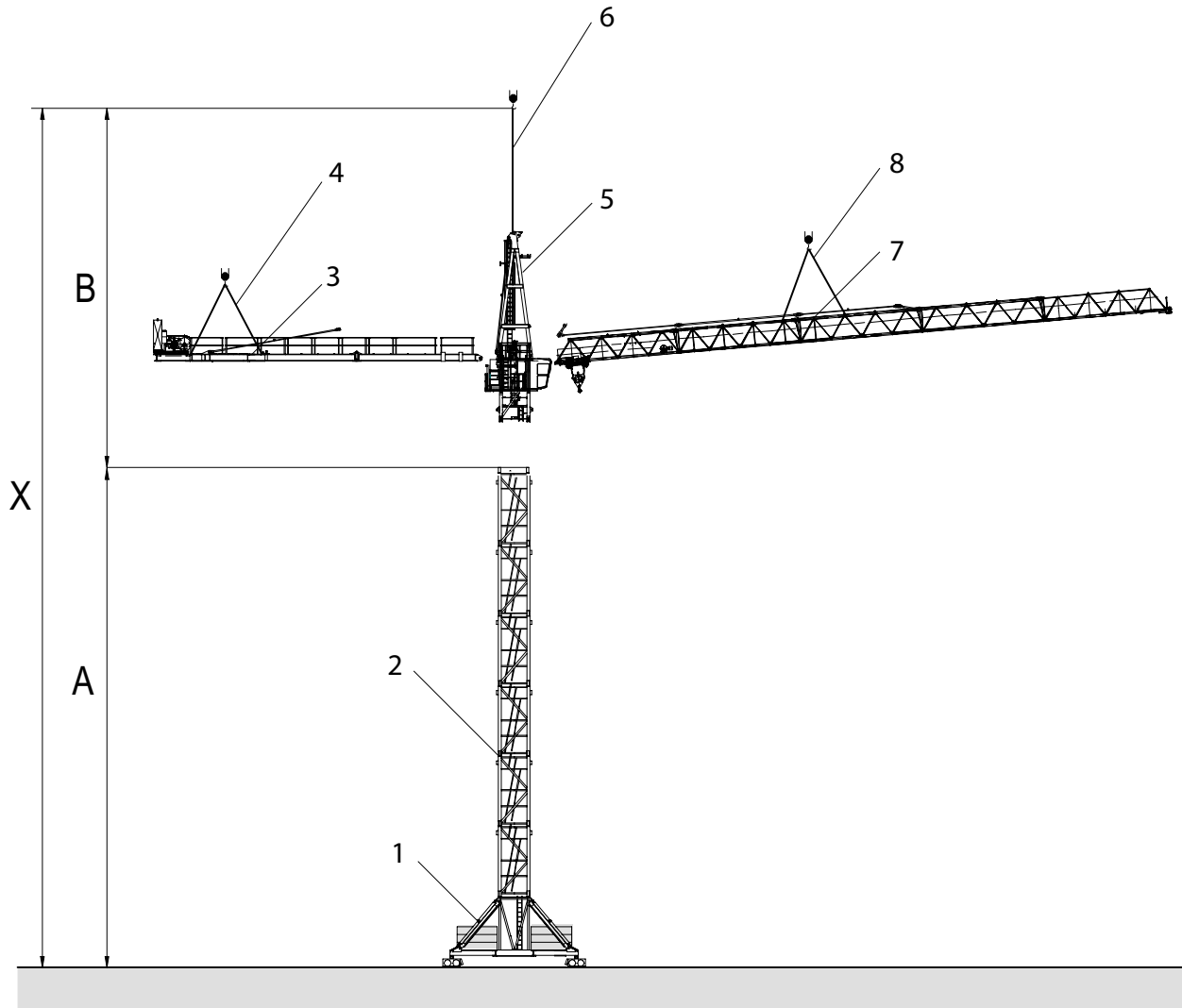

Exemplary illustration

[A]	Height of the WOLFF slewing tower crane	[B]	Clearance 15 m
[X]	Hook height above ground required for the mobile crane		
1	Substructure	5	Tower head section, complete
2	Tower element	6	Single-point lifting tackle (1 m with shackle)
3	Counterjib including hoisting winch platform	7	Jib, complete
4	Four-point lifting tackle (6 m with shackle)	8	Four-point lifting tackle (6 m with shackle)

(see also):

- Tower combinations [\[11\]](#)

8 Assembly diagrams

8 Assembly diagrams

8.1 Jib attachment diagram

	NOTICE
	For jib assembly, use a Four-point lifting tackle (6 m with shackle).

Length of jib elements

Item	Length [m]
Jib element 1, 2, 3, 4, 6, 7, 8	10.0
Jib element 5	5.0

8.1.1 Trolley jib - attachment diagram 75 m to 60 m

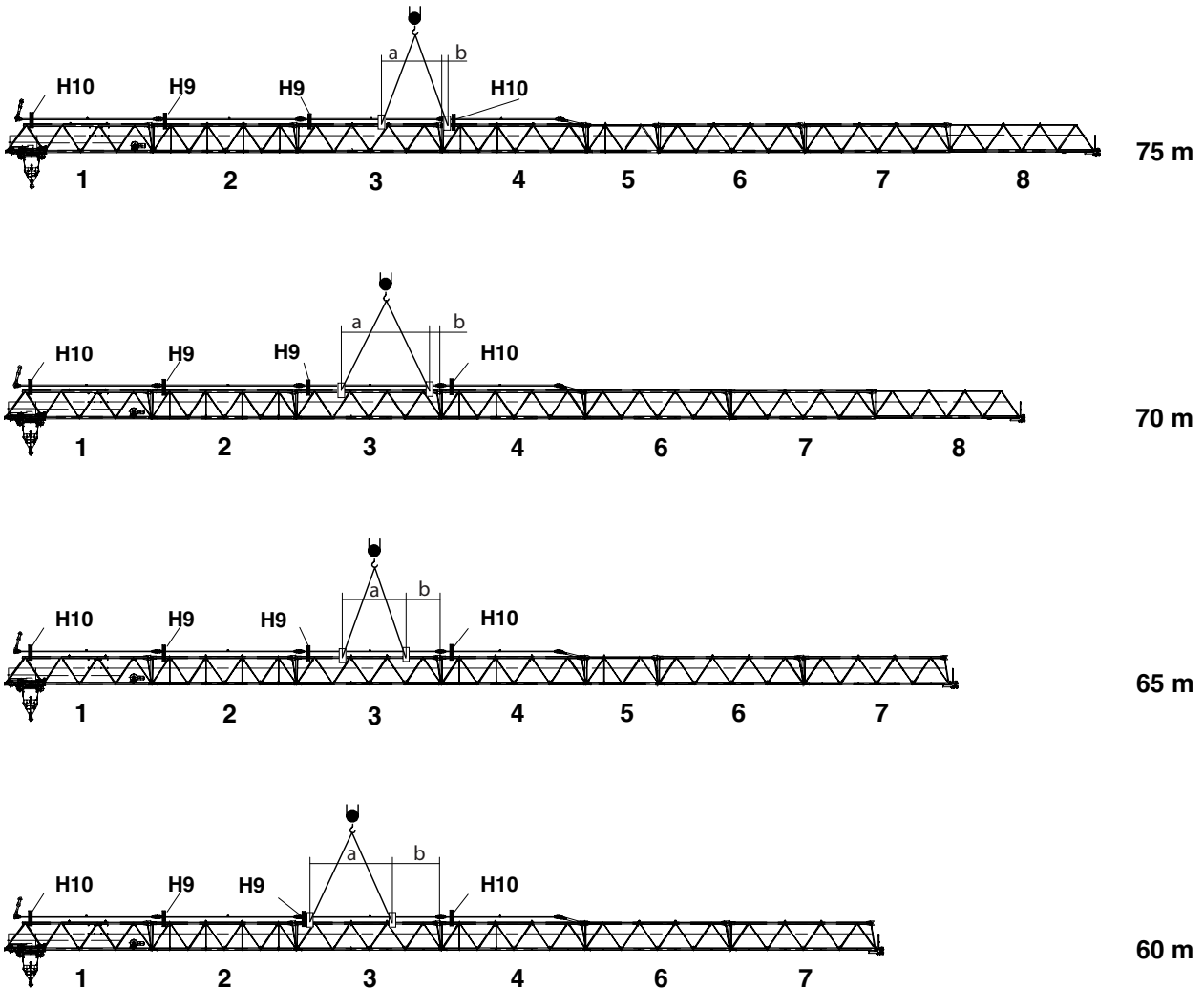

a	Dimension a	H9	Mounting rig H9
b	Dimension b	H10	Mounting rig H10

Attachment data 7532 cross

Data	Jib length [m]			
	75.0	70.0	65.0	60.0
a [m]	3.92	5.50	4.27	1.08
b [m]	0.52	0.92	2.15	5.51
Weight [kg]	17700	16800	16700	15800

8 Assembly diagrams

8.1.2 Trolley jib - attachment diagram 55 m to 45 m

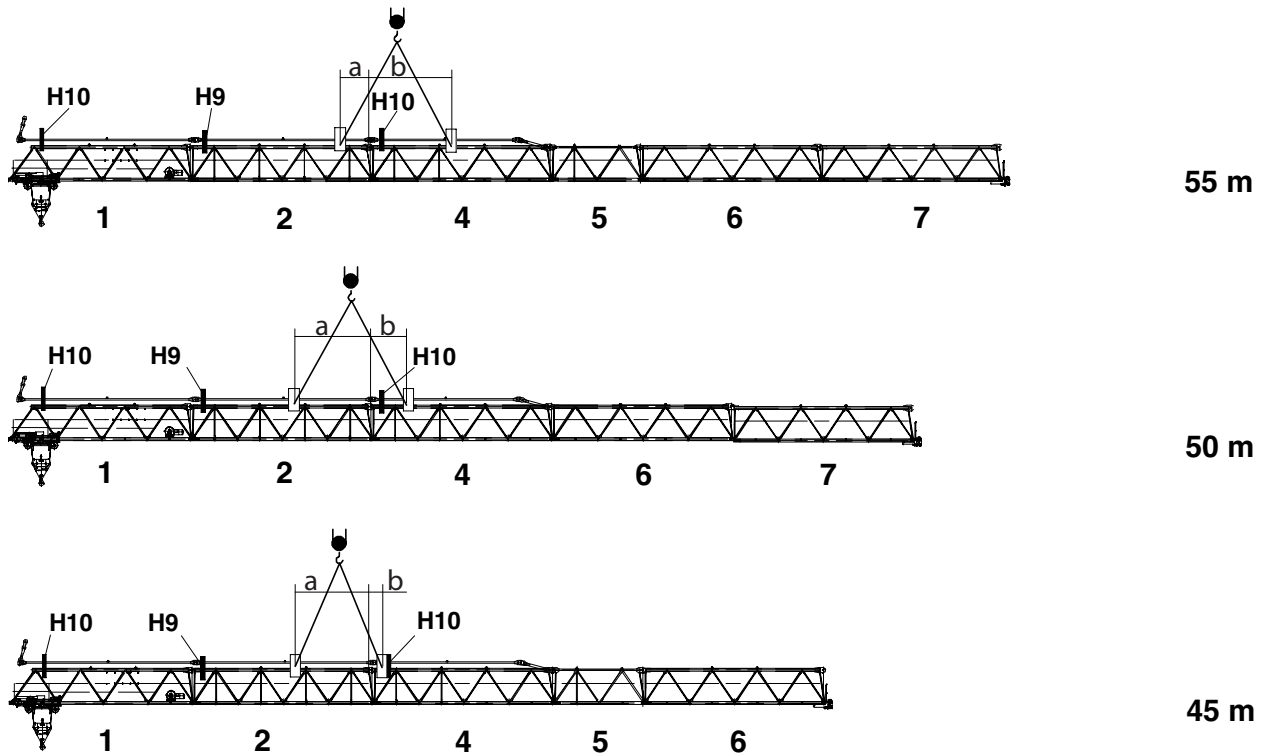

a	Dimension a	H9	Mounting rig H9
b	Dimension b	H10	Mounting rig H10

Attachment data 7532 cross

Data	Jib length [m]		
	55.0	50.0	45.0
a [m]	1.44	3.94	3.94
b [m]	4.11	1.61	0.52
Weight [kg]	14200	13200	12900

8.1.3 Trolley jib - attachment diagram 40 m to 30 m

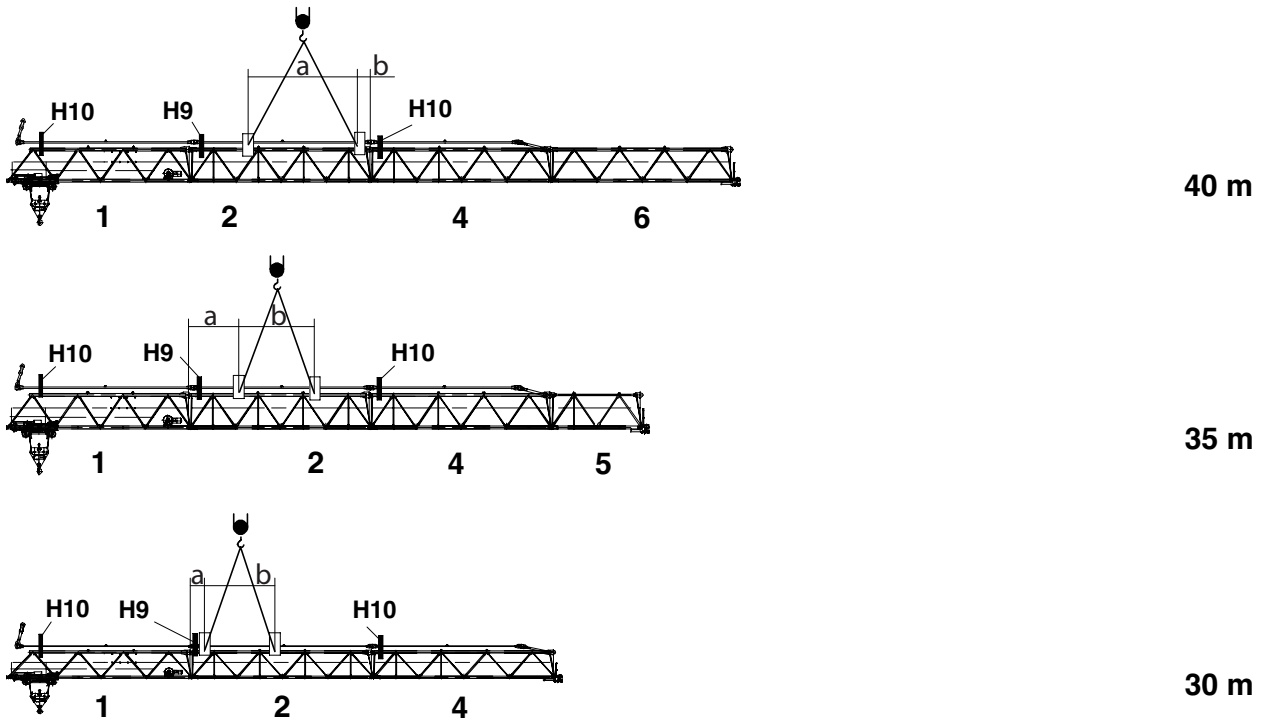

Attachment data 7532 cross

Data	Jib length [m]		
	40.0	35.0	30.0
a [m]	5.54	2.70	1.06
b [m]	0.90	3.90	3.60
Weight [kg]	12000	11300	10300

8 Assembly diagrams

8.2 Jib brace diagram

Jib brace diagram 75m – 60m

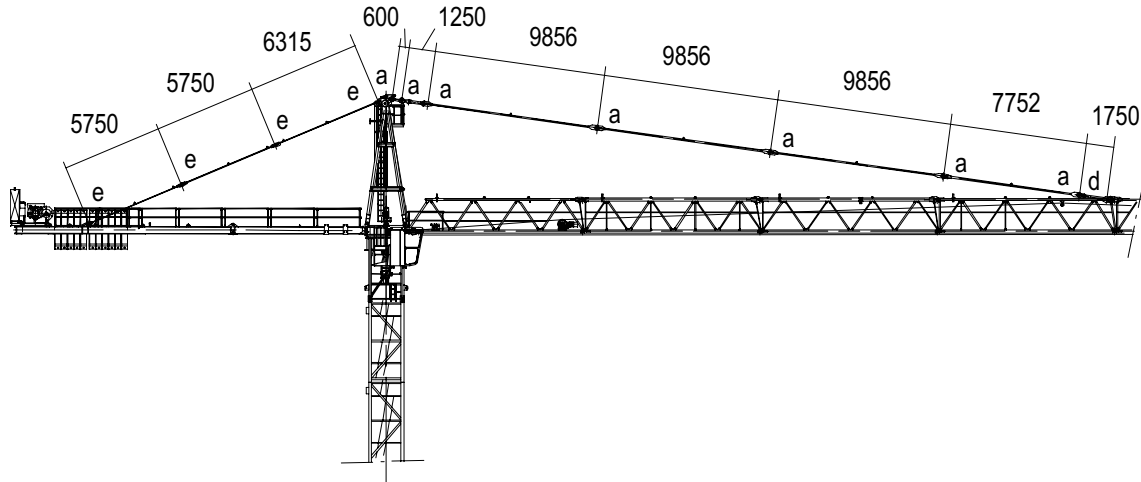

Bolt table

Jib length	Item	Bolts		Fuse	
		Quantity	Dimension [mm]	Quantity	Dimension [mm]
Jib 75m – 60m	a	7	Ø 100/90x225	7	Spring retainers Ø10/60-80, steel galvanized, yellow
	d	1	Ø 100/90x300	1	Axle retainer 40x10x140
				2	Hex. screws M16x30 DIN 933-8.8 galv.
				2	Lock washer A 16 DIN 127 Fed.steel, galvanized
Counterjib	e	8	Ø 70/60x150mm	8	Spring retainers Ø10/60-80, steel galvanized, yellow

Jib brace diagram 55m – 30m

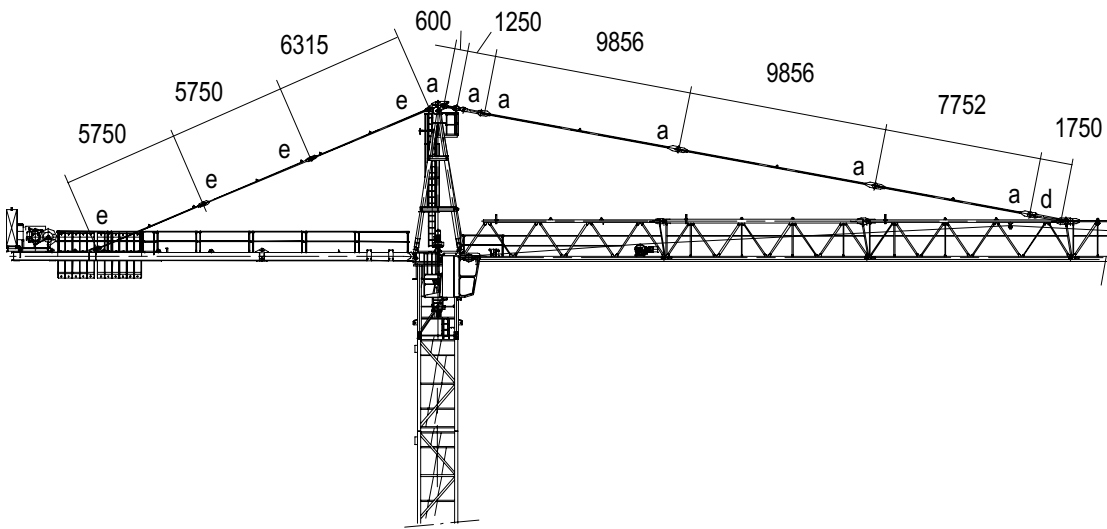

Bolt table

Jib length	Item	Bolts		Fuse	
		Quantity	Dimension [mm]	Quantity	Dimension [mm]
Jib 55m – 30m	a	6	Ø 100/90x225	6	Spring retainers Ø10/60-80, steel galvanized, yellow
	d	1	Ø 100/90x300	1	Axle retainer 40x10x140
				2	Hex. screws M16x30 DIN 933-8.8 galv.
				2	Lock washer A 16 DIN 127 Fed.steel, galvanized
Counterjib	e	8	Ø 70/60x150mm	8	Spring retainers Ø10/60-80, steel galvanized, yellow

8.3 Trolley jib mounting rig

	NOTICE
	<p>For information on the arrangement of the mounting rig, refer to the attachment diagram.</p> <p>Two mounting rigs are required per slewing tower crane.</p>

Elements required for each mounting rig

Quantity	Item	Dimensions	Material
1	Mounting rig		
4	Hexagonal head bolt	M16 x 220	ISO 4014-8.8 galv.
4	HSFG washer	17	EN 14399 galvanized
4	Hexagonal nut	M16	ISO 4032-8 galvanized
4	Hexagonal nut	M16	DIN 7967, galvanized

Mounting rig

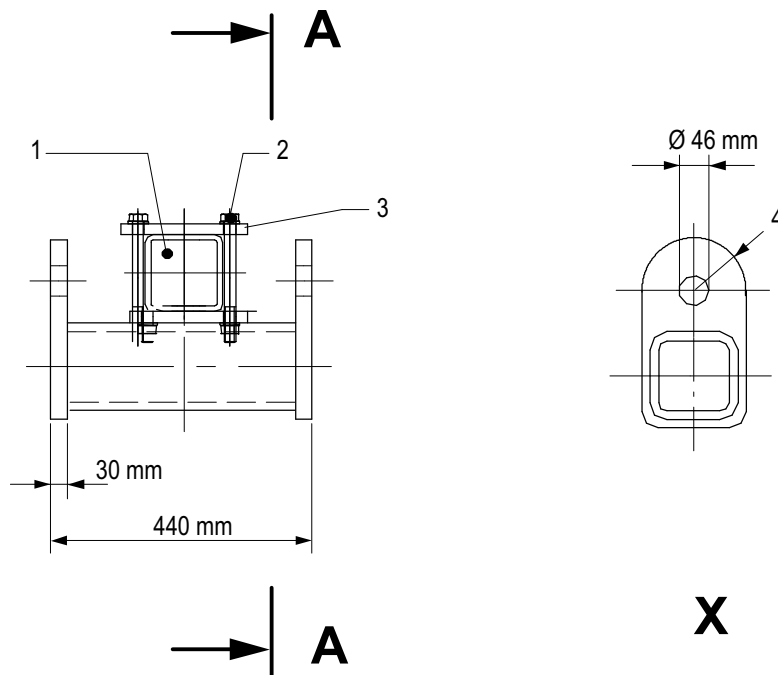

1	Top chord trolley jib	4	Radius 65 mm
2	Hexagonal head screw	A	Section A-A
3	Metal plate 12x240x240	X	View section A-A

8.4 Mounting rig for trolley jib

	NOTICE	
	<p>For information on the arrangement of the mounting rig, refer to the attachment diagram. For information on the arrangement of the mounting rig, refer to the attachment diagram.</p> <p>Two mounting rigs are required per slewing tower crane.</p>	

Dimensions for mounting rig

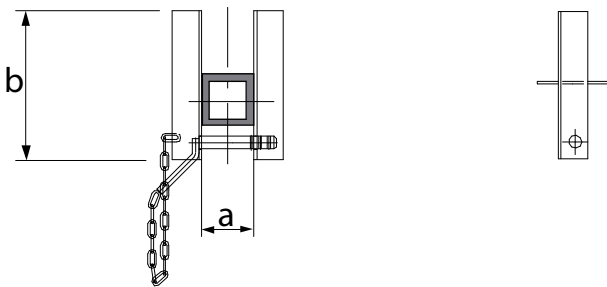

Mounting rig H9

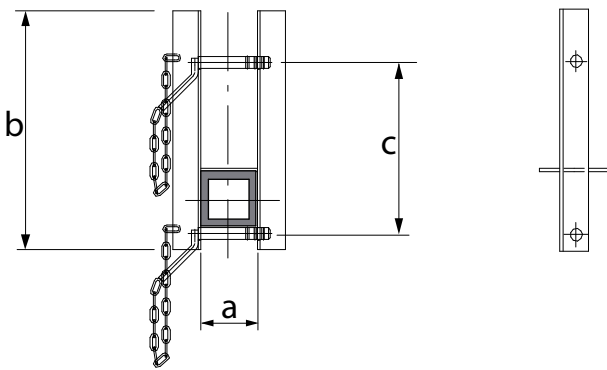

Mounting rig H10

Type	Dimensions		
	a [mm]	b [mm]	c [mm]
H9	164	450	–
H10	144	450	312

8 Assembly diagrams

8.5 Arrangement of standard railings

8.5.1 Standard railings (NG) and accessories

Arrangement of standard railings Hw875FU





Quantity	Standard railings (NG)/ accessories	Dimensions / spacing of posts / height
4	Standard posts (NP)	–
1	Standard posts with holder (NPF)	–
1	Flagpole holder (F*)	1400 mm
1	NGE 300	–
1	Standard railing 350	200 mm
2	Standard railing 500	400 mm
3	Standard railing 750	600 mm
6	Standard railing 1000	900 mm
2	Standard railing 1500	1400 mm
5	Standard railing 2000	1900 mm
12	Standard railing 2500	2400 mm
1	Hoop guard (RS)	–
1	Support block AB 1	700 mm
1	Support block AB 2	1400 mm

9 Suitable climbing devices



9 Suitable climbing devices

This section contains information on

- Outer climbing devices (KWH)
- Inner climbing devices (KSH)

	<p style="text-align: center;">NOTICE</p> <p>Details on the climbing device Always refer to the details in the documentation of the climbing device.</p>
	<p style="text-align: center;">NOTICE</p> <p>The operating radius specified is measured from the tower center and is to be considered a reference value. Exact balancing can be achieved by changing the operating radius with the tower elements or loads specified in the table.</p>
	<p style="text-align: center;">NOTICE</p> <p>Details for climbing balancing The climbing balancing details apply to the snatch block in maximum hook position.</p>
	<p style="text-align: center;">NOTICE</p> <p>If feasible, preferably operate your climbing device without balancing weight.</p>

9.1 Outer climbing devices

	<p style="text-align: center;">! DANGER</p> <p>Climbing device attached to the lower part of the tower head section lower part.</p> <p>Increased wind surface. The slewing tower crane may overturn.</p> <ul style="list-style-type: none">▶ Dismantle the climbing device after the climbing procedure is finished or lower the climbing device down on the ground or lower the climbing device down to the uppermost tower brace.
	<p style="text-align: center;">NOTICE</p> <p>Tower element on the transfer carriage</p> <p>The data on climbing balance was specified under the assumption that a tower element is on the transfer carriage.</p>

9 Suitable climbing devices

9.1.1 Outer climbing device KWH 20.3 / KWH 20.3.1

Climbing radius [m] for the balancing weights - WOLFF 7532.16

7532.16	Jib length [m]				
	75	70	65	60	55
no weight	31.8	49.8	-	-	-
UV 20.4 = 2.05 t	-	-	22.3	27.4	37.0
TV 20.4 = 2.98 t	-	-	16.3	20.3	27.8
Weight = 5.0 t	-	-	-	-	-

Climbing radius [m] for the balancing weights - WOLFF 7532.16

7532.16	Jib length [m]				
	50	45	40	35	30
no weight	-	-	-	-	-
UV 20.4 = 2.05 t	39.8	35.0	-	-	-
TV 20.4 = 2.98 t	30.0	26.3	34.1	-	-
Weight = 5.0 t	-	-	22.7	22.2	21.8

9.1.2 Outer climbing device KWH 20.6 / KWH 20.6.1 / KWH 20.6.2

Climbing radius [m] for the balancing weights - WOLFF 7532.16

7532.16	Jib length [m]				
	75	70	65	60	55
no weight	30.0	48.0	-	-	-
UV 20.4 = 2.05 t	11.9	18.9	21.6	26.7	36.3
TV 20.4 = 2.98 t	8.2	13.7	15.8	19.8	27.3
Weight = 5.0 t	-	-	10.3	13.0	18.1

Climbing radius [m] for the balancing weights - WOLFF 7532.16

7532.16	Jib length [m]				
	50	45	40	35	30
no weight	-	-	-	-	-
UV 20.4 = 2.05 t	39.1	34.3	-	-	-
TV 20.4 = 2.98 t	29.5	25.8	33.5	-	-
Weight = 5.0 t	19.6	17.1	22.4	21.8	21.4

9 Suitable climbing devices

9.2 Inner climbing devices

	NOTICE
	The data required and the instructions for tower assemblies with inner climbing device is available in the separate description of the inner climbing device.

DANGER! Observe the special tower combination for the inner climbing device.

	NOTICE
	Clamping forces for the inner climbing device (KSH) are specified based on a building height of < 250m and wind category C 25.

9.2.1 Inner climbing device KSH 20 SH

Tower combinations for slewing tower cranes with inner climbing device.

Item				
1	UV 20.4	UV 20.4	UV 20.4	UV 20.4
2	UV 20.4	UV 20.4	UV 20.4	UV 20.4
3	UV 20.4	UV 20.4	UV 20.4	UV 20.4
4	UV 20.4	UV 20.4	UV 20.4	UV 20.4
5	UV 20.4	UV 20.4	UV 20.4	UV 20.4
6	TVA 20.4	TVA 20.4	TVA 20.4	TVA 20.4
7	TV 20.4	TV 20.4	TV 20.4	
8	TV 20.4	TV 20.4		
9	TV 20.4			
inner climbing device	KSH 20 SH	KSH 20 SH	KSH 20 SH	KSH 20 SH
Foundation	FUA TYPE FS-156 / FUA 156S	FUA TYPE FS-156 / FUA 156S	FUA TYPE FS-156 / FUA 156S	FUA TYPE FS-156 / FUA 156S
Tower height [m]	55.5	51.0	46.5	42.0
Hook height (2 fall operation) [m]	57.0	52.5	48.0	43.5
Hook height (4 fall operation) [m]	56.6	52.1	47.6	43.1

Climbing radius [m] for the balancing weights - WOLFF 7532.16

7532.16	Jib length [m]				
	75	70	65	60	55
UV 20.4 = 2.05 t	42.6	48.2	51.0	54.7	-
TV 20.4 = 2.98 t	33.3	37.7	39.9	42.8	49.1
Weight = 5.0 t	-	-	-	29.0	33.3
Weight = 8.0 t	-	-	-	-	-

Climbing radius [m] for the balancing weights - WOLFF 7532.16

7532.16	Jib length [m]				
	50	45	40	35	30
UV 20.4 = 2.05 t	-	-	-	-	-
TV 20.4 = 2.98 t	-	-	-	-	-
Weight = 5.0 t	34.1	31.0	36.1	-	-
Weight = 8.0 t	-	-	-	23.6	22.9

9 Suitable climbing devices

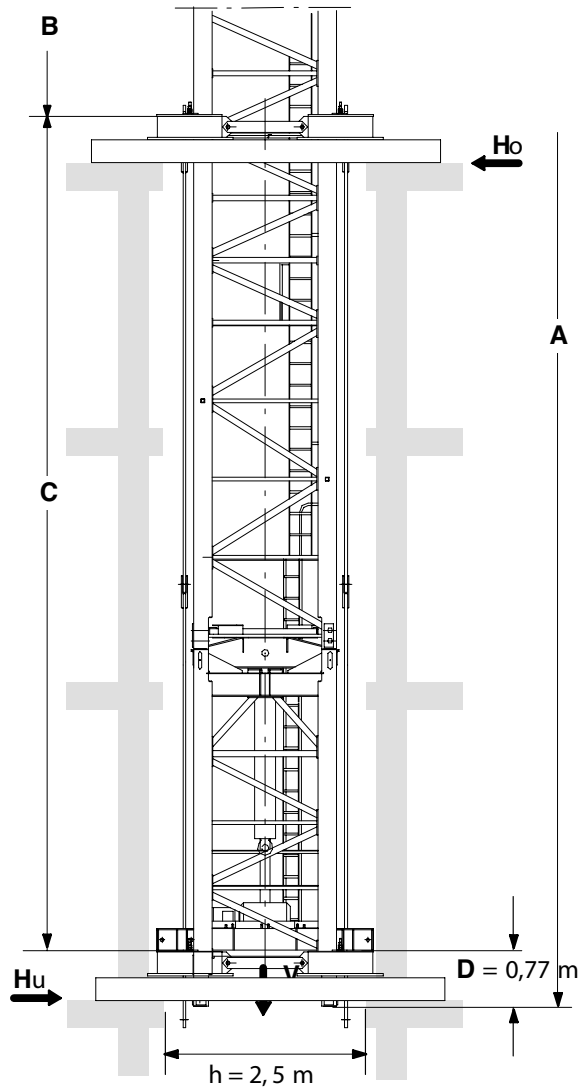

$$C_{\min} = 11,0 \text{ m}$$

$$C_{\max} = 14,0 \text{ m}$$

$$H_o = \frac{M}{C} + H$$

$$H_u = H_o - H$$

$$T = \frac{M_D}{2 \times b}$$

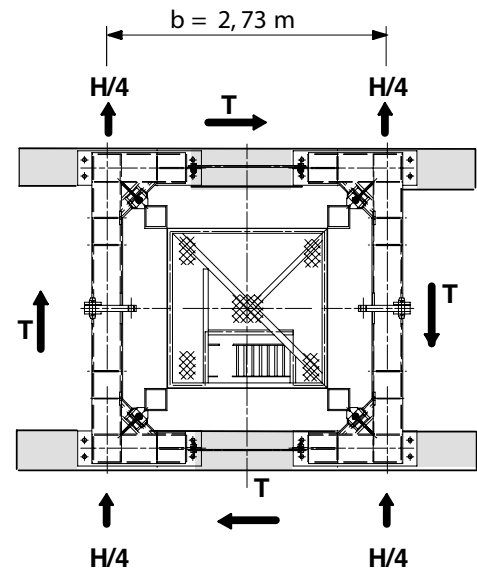

A	Tower height	C	Distance between guide frames
B	A-C-D		

In service clamping forces

In service clamping forces [kN] inside a building																
A [m]	55.5				51.0				46.5				42.0			
C [m]	11.0	12.0	13.0	14.0	11.0	12.0	13.0	14.0	11.0	12.0	13.0	14.0	11.0	12.0	13.0	14.0
V	1286				1258				1229				1201			
Ho	450	410	380	350	420	390	360	330	400	370	340	320	380	350	320	300
Hu	400	360	330	300	380	340	310	290	360	320	300	270	340	310	280	260
T	72				72				72				72			

Out of service clamping forces

Out of service clamping forces [kN] inside a building																
A [m]	55.5				51.0				46.5				42.0			
C [m]	11.0	12.0	13.0	14.0	11.0	12.0	13.0	14.0	11.0	12.0	13.0	14.0	11.0	12.0	13.0	14.0
V	1107				1079				1051				1022			
Ho	800	730	680	630	700	640	600	550	610	560	520	480	530	480	450	420
Hu	560	490	430	390	470	410	360	320	390	340	300	260	320	280	240	210
T	-				-				-				-			

10 Arrangement of counterweight blocks

10 Arrangement of counterweight blocks

L = 75 m	L = 70 m	L = 65 m	L = 60 m	L = 55 m
11 x 2.7 t	10 x 2.7 t	10 x 2.7 t	9 x 2.7 t	8 x 2.7 t
W = 31.7 t	W = 29.0 t	W = 29.0 t	W = 26.3 t	W = 23.6 t
Permanent counterweight below machine platform = 2.0 t				
L = 50 m	L = 45 m	L = 40 m	L = 35 m	L = 30 m
7 x 2.7 t	6 x 2.7 t	6 x 2.7 t	5 x 2.7 t	4 x 2.7 t
W = 20.9 t	W = 18.2 t	W = 18.2 t	W = 15.5 t	W = 12.8 t
Permanent counterweight below machine platform = 2.0 t				

	Intermediate ballast 1 x 2.7 t		Counterweight block 1 x 2.7 t
	No counterweight	L	Jib length [m]
a	To the tower	G	Total weight [t]

WOLFFKRAN Group

Headquarter international:

WOLFFKRAN AG

Baarermattstraße 6

CH-6300 Zug

Switzerland

Phone +41 41 766 85 00

Fax +41 41 766 85 99

info@wolffkran.com

Manufacturing:

WOLFFKRAN GmbH

Austraße 72

D-74076 Heilbronn

Germany

Phone + 49 7131 9815 0

Fax + 49 7131 9815 355

info@wolffkran.de

WOLFFKRAN Werk Brandenburg GmbH

Frederik-Ipsen-Straße 5

D-15926 Luckau OT Alverno

Germany

Phone + 49 35456 674 0

Fax + 49 35456 674 200

info@wolffkran.de